

Applicable Model

S532

Drawing Title

Intercom Panel

Drawing Unit

mm

Drawing Scale

Not to scale

**DRAFT
SUBJECT TO
CHANGE**

Last Revised

May 30, 2024

Drawing Version

V1.0

Page

1 of 10

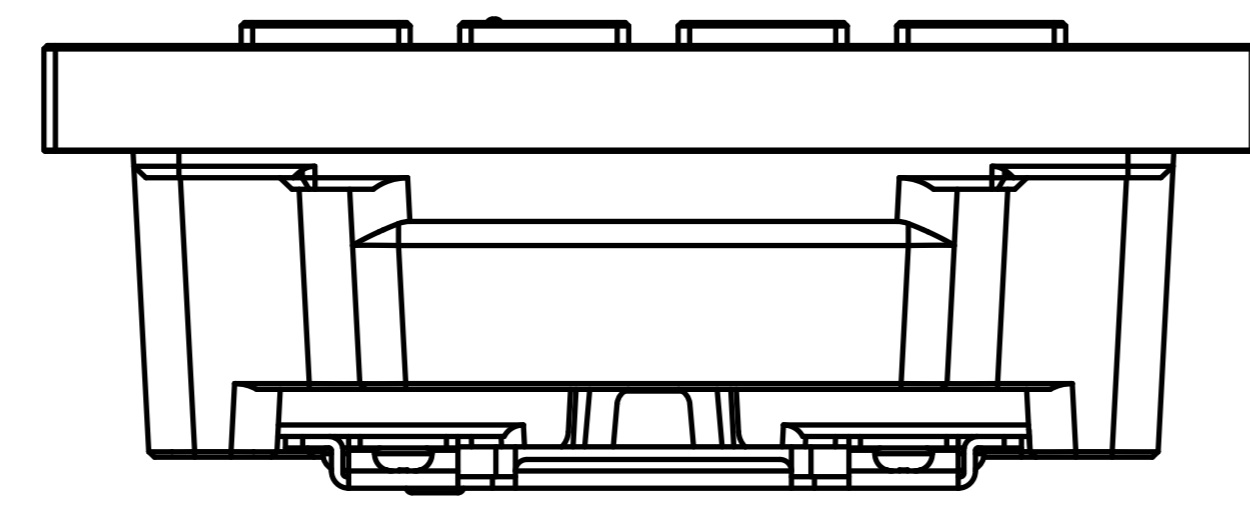

⑥ BOTTOM VIEW

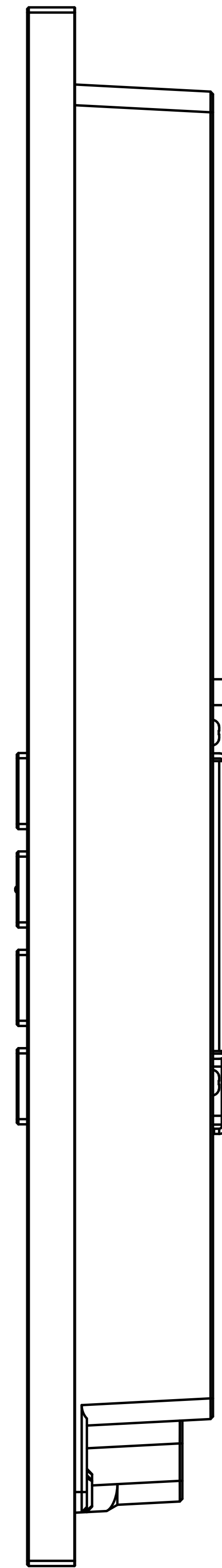

② RIGHT VIEW

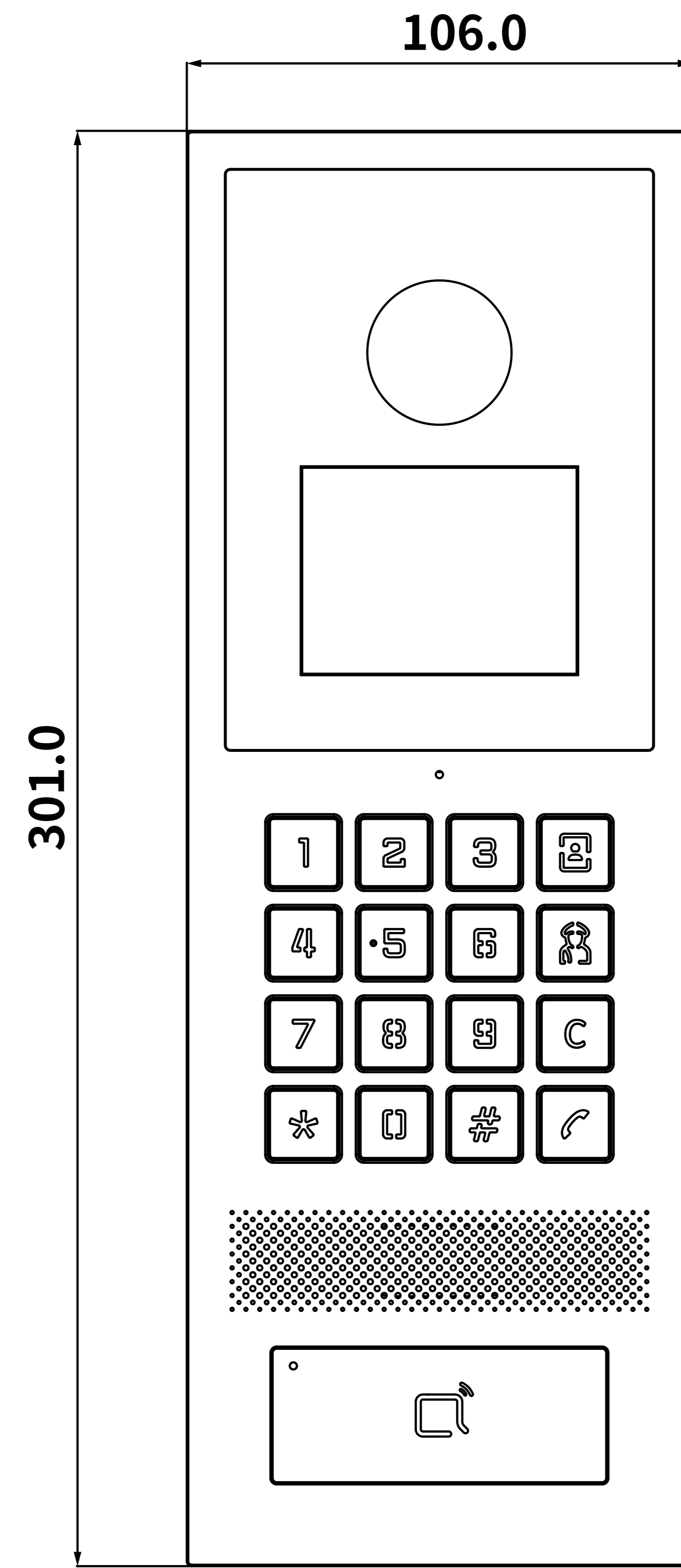

① FRONT VIEW

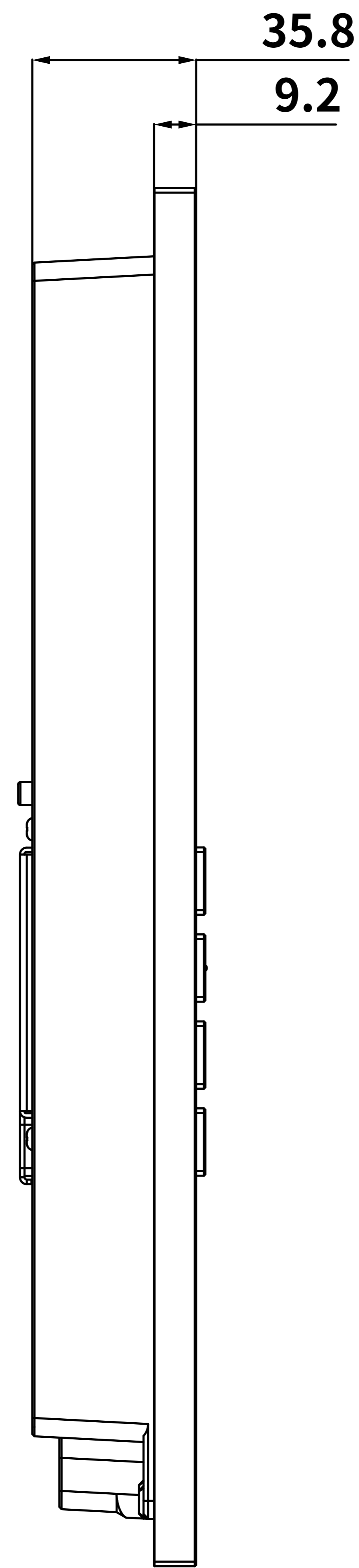

③ LEFT VIEW

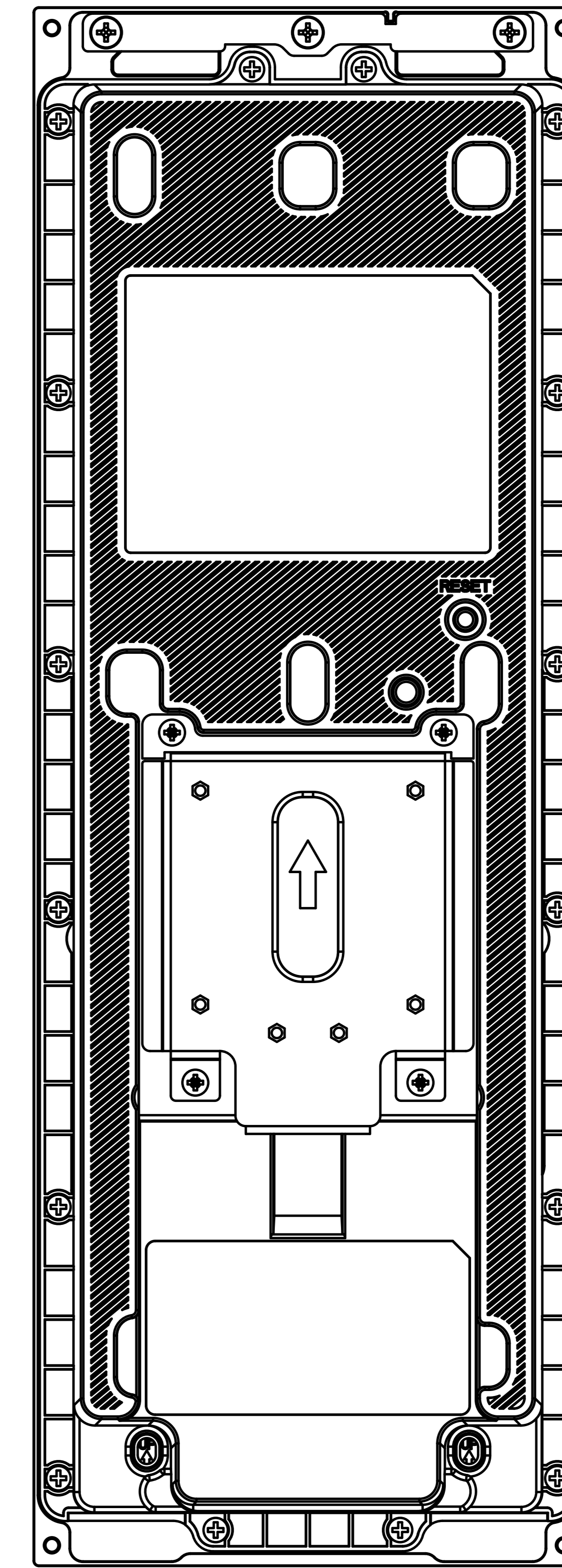

④ BACK VIEW

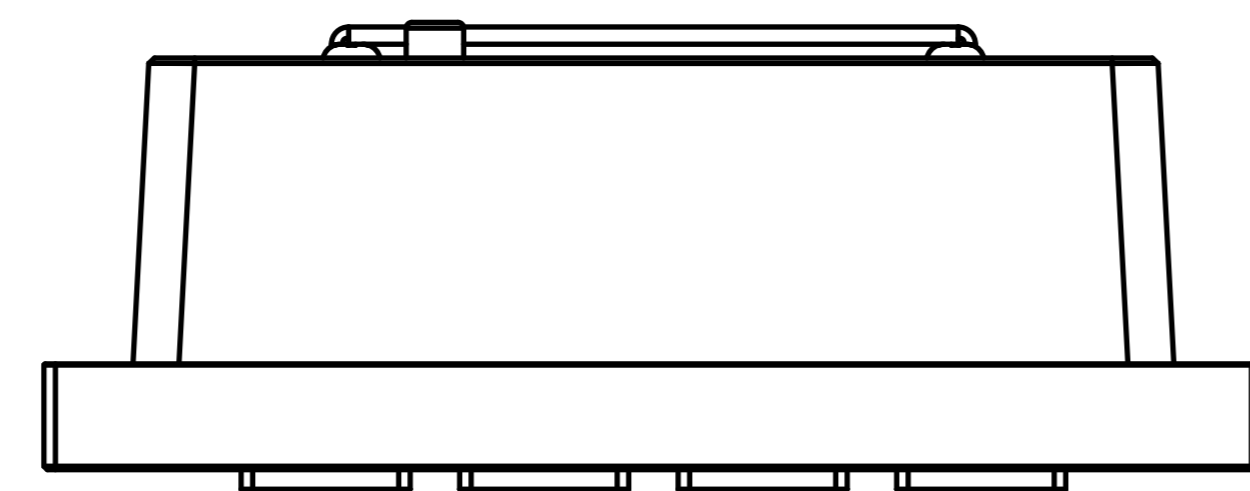

⑤ TOP VIEW

Applicable Model

S532

Drawing Title

Wall Mounting Box

Drawing Unit

mm

Drawing Scale

Not to scale

**DRAFT
SUBJECT TO
CHANGE**

Last Revised

May 30, 2024

Drawing Version

V1.0

Page

2 of 10

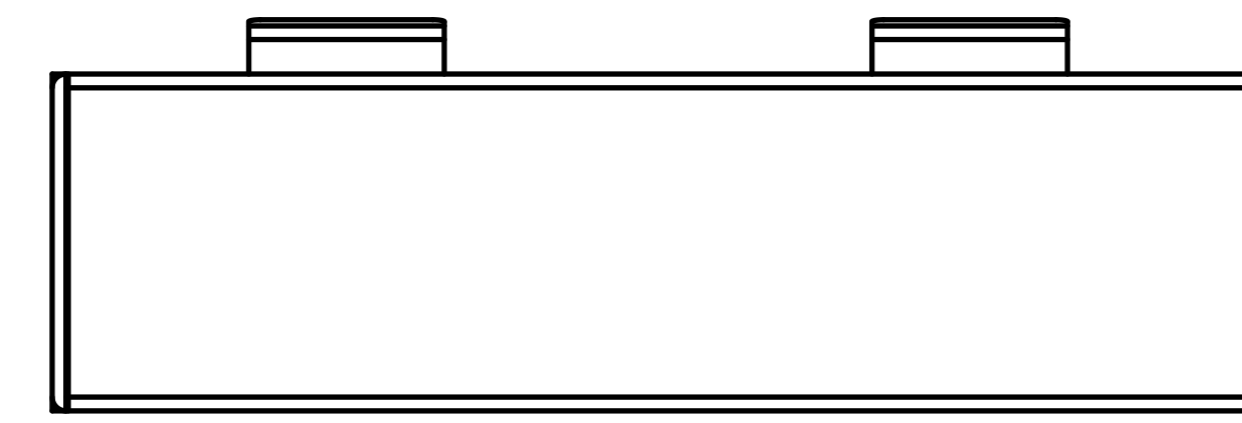

⑥ BOTTOM VIEW

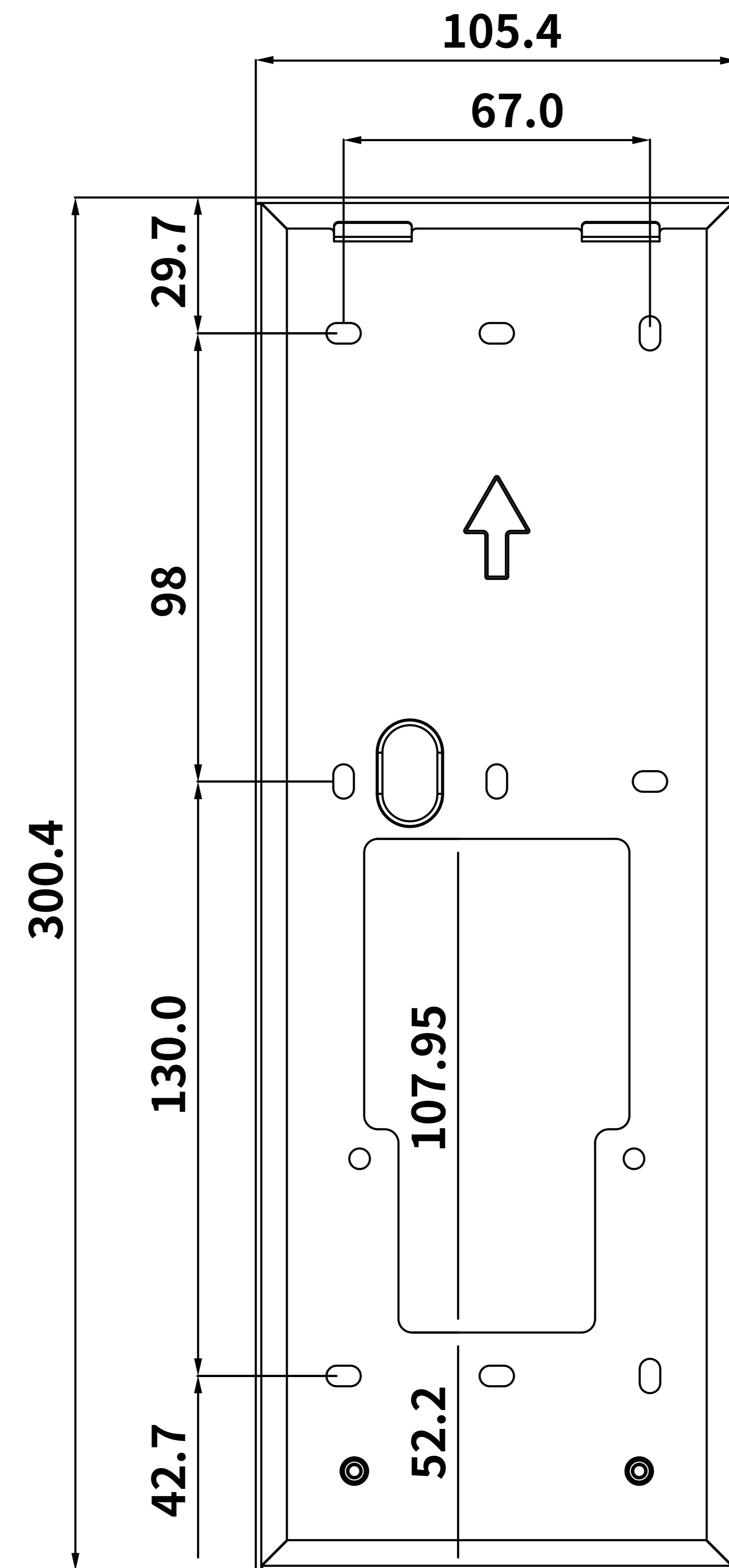

① FRONT VIEW

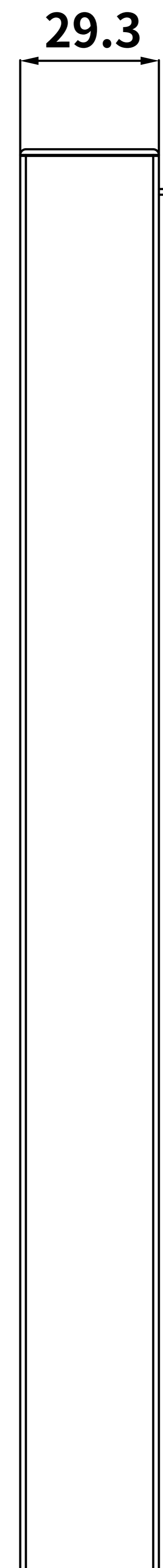

③ LEFT VIEW

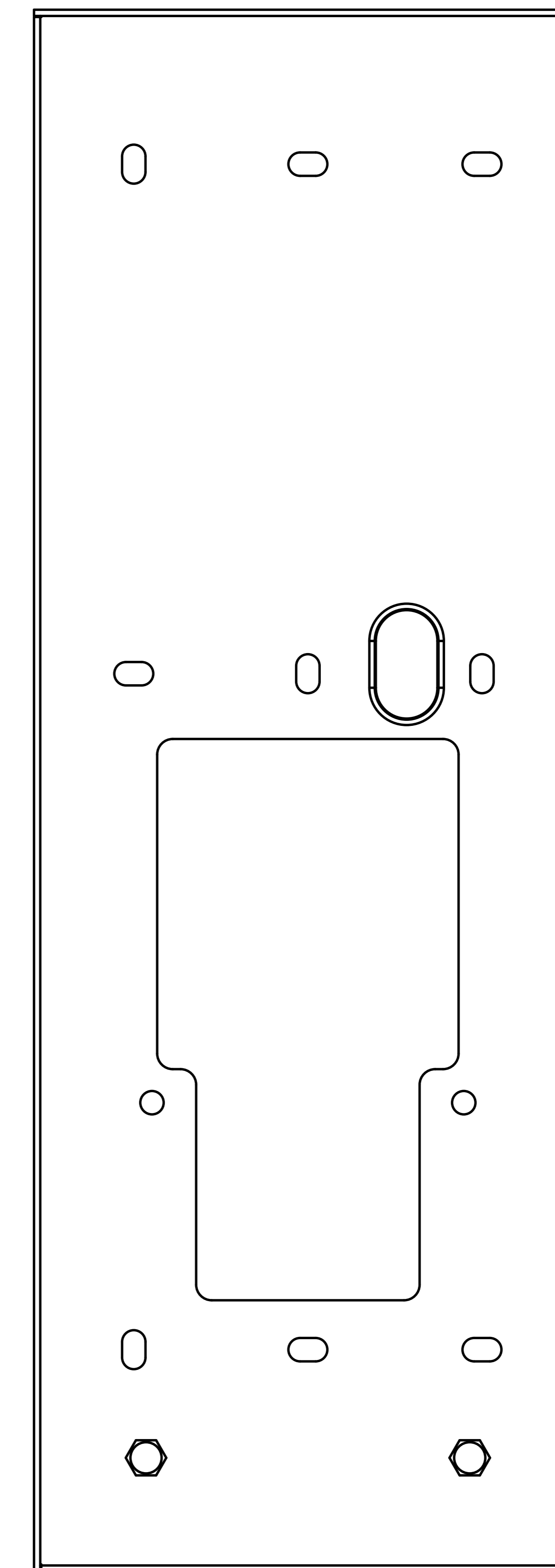

④ BACK VIEW

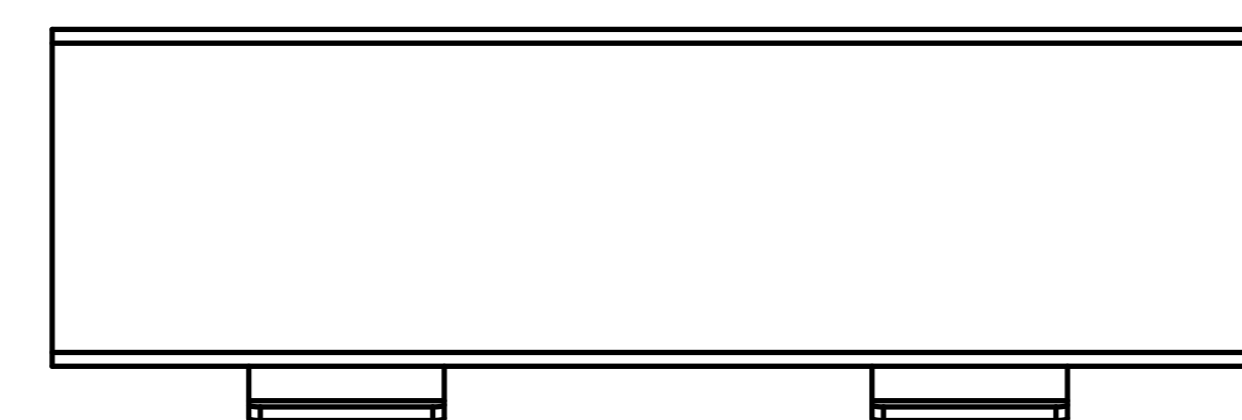

⑤ TOP VIEW

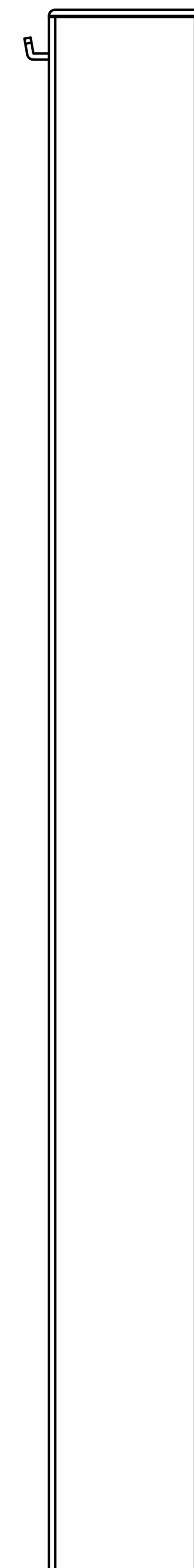

② RIGHT VIEW

Applicable Model
S532

Drawing Title
Placement

Drawing Unit
mm

Drawing Scale
Not to scale

DRAFT
SUBJECT TO
CHANGE

Last Revised
May 30, 2024

Drawing Version
V1.0

Page
3 of 10

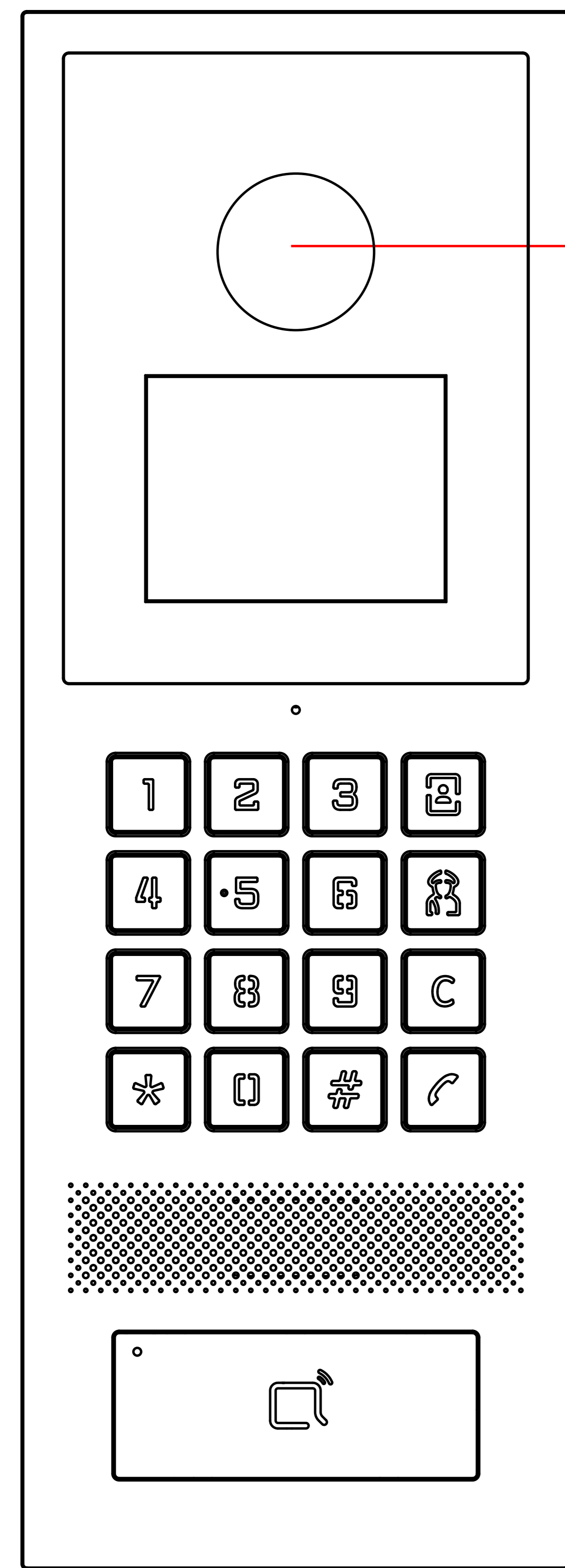

① INTERCOM PANEL FRONT VIEW

1245.5mm TO BOTTOM OF PANEL

1500mm TO CENTER OF CAMERA

ADA Compliance Requirement

GROUND

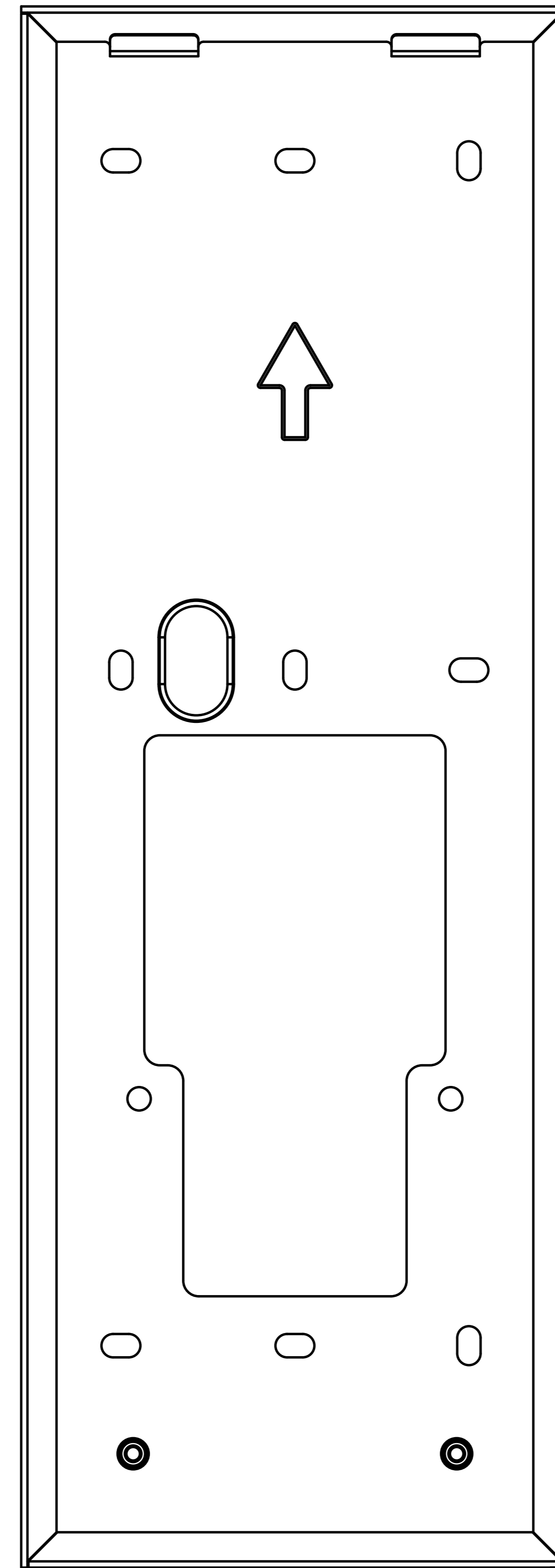

② FRONT VIEW: WALL MOUNTING BOX PLACEMENT

1245.8mm TO BOTTOM OF BOX

GROUND

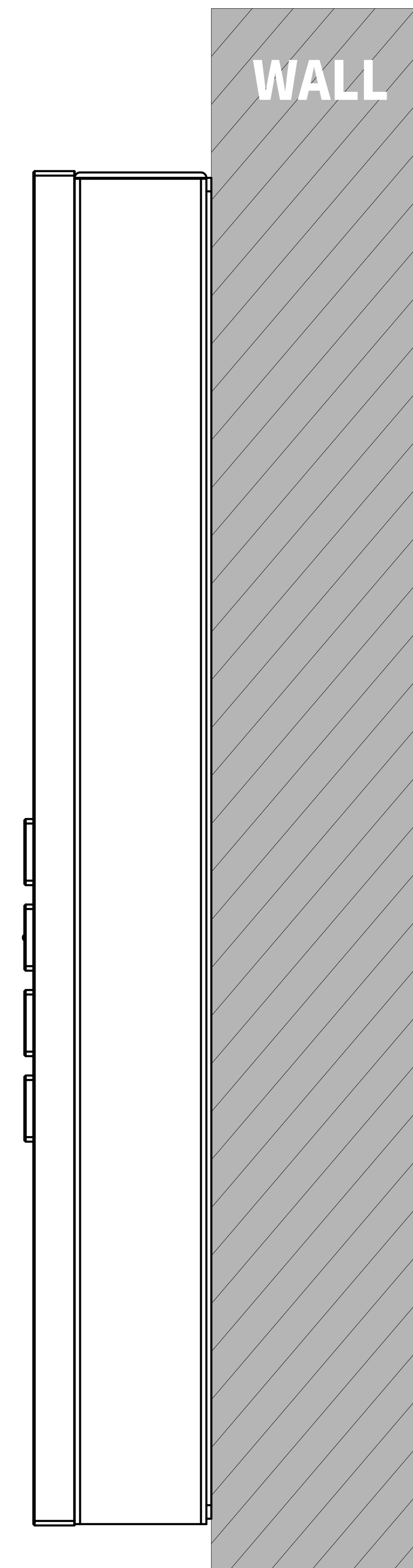

③ SIDE VIEW: INTERCOM ON WALL

Applicable Model

S532

Drawing Title

On-Wall Mounting
Rain Cover

Drawing Unit

mm

Drawing Scale

Not to scale

**DRAFT
SUBJECT TO
CHANGE**

Last Revised

May 30, 2024

Drawing Version

V1.0

Page

4 of 10

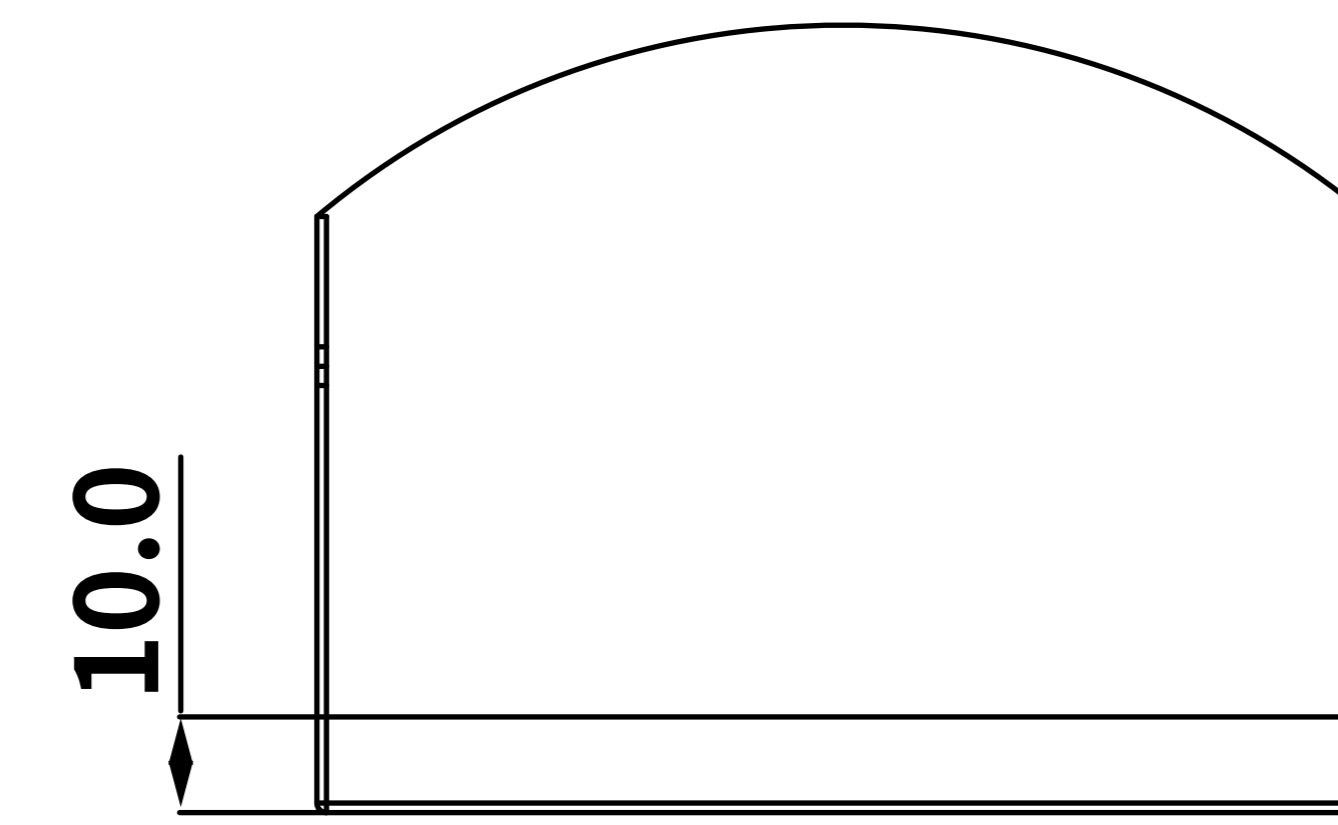

⑥ BOTTOM VIEW

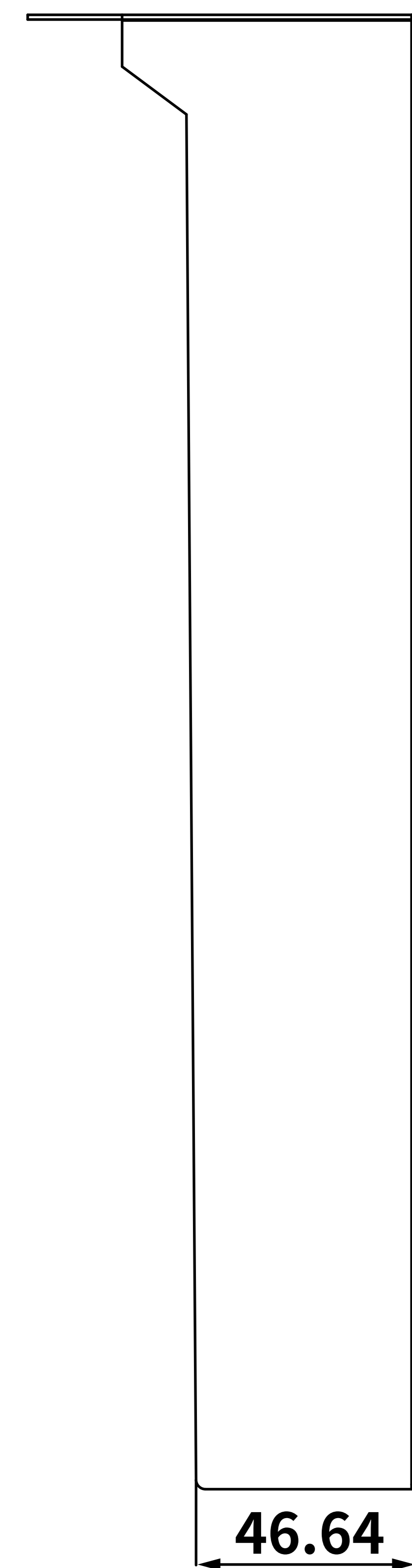

② RIGHT VIEW

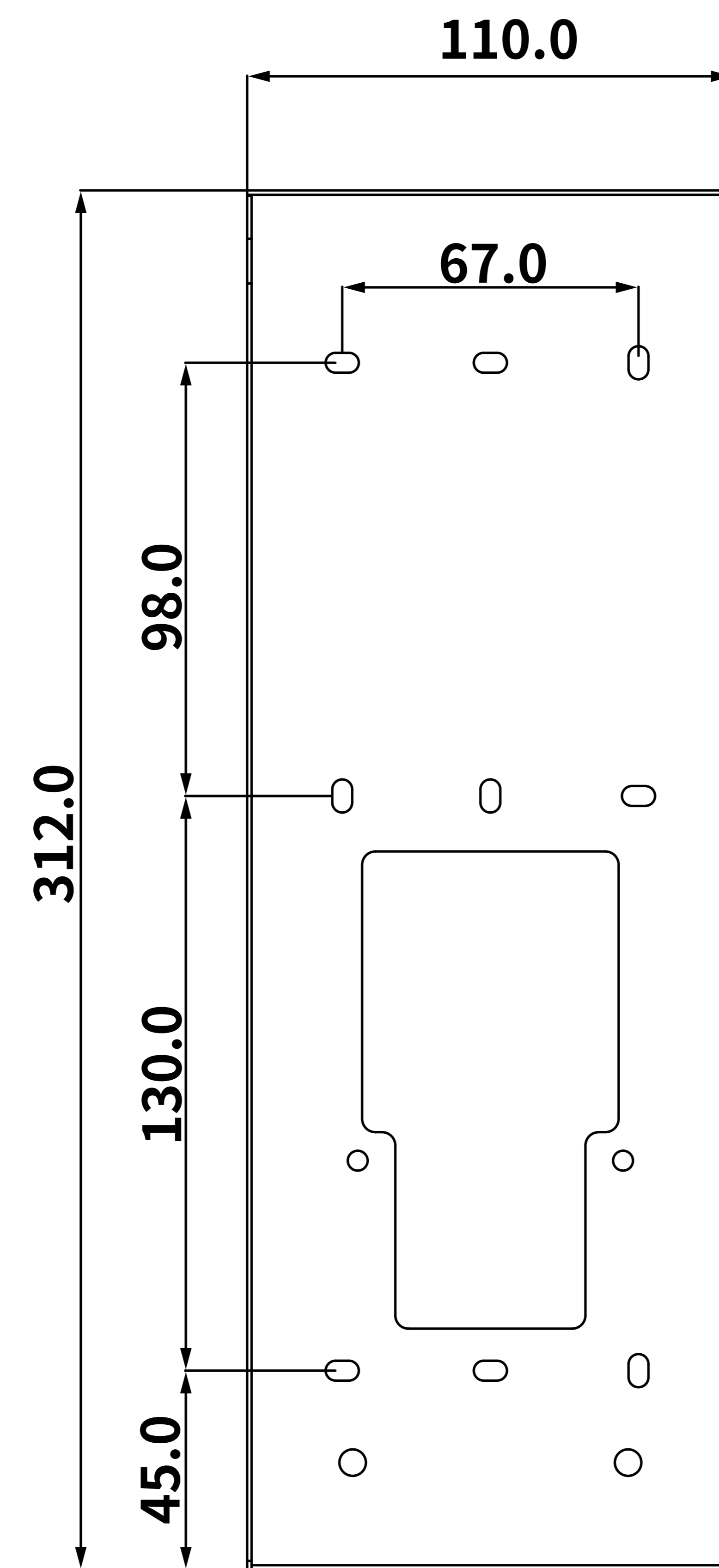

① FRONT VIEW

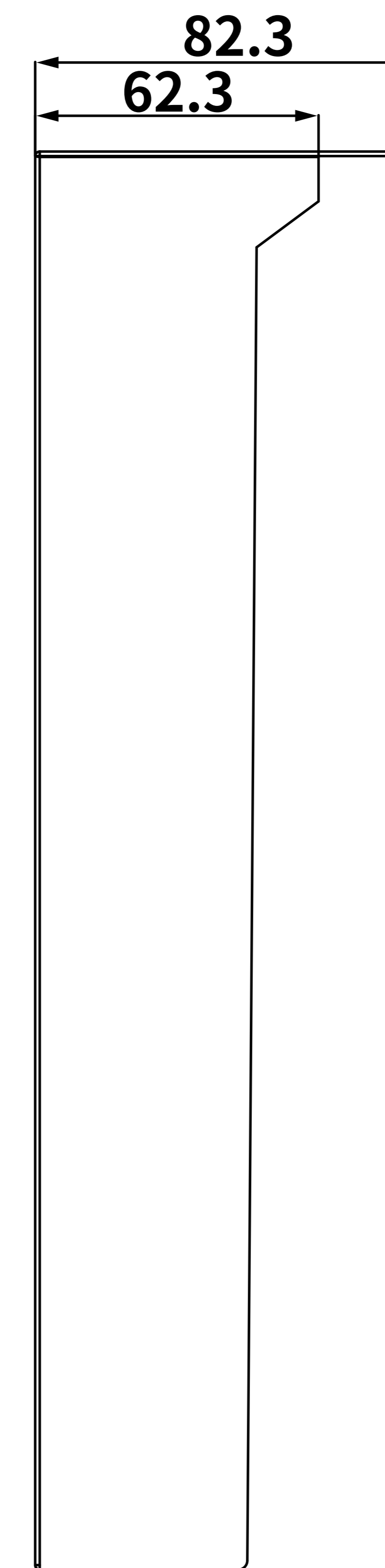

③ LEFT VIEW

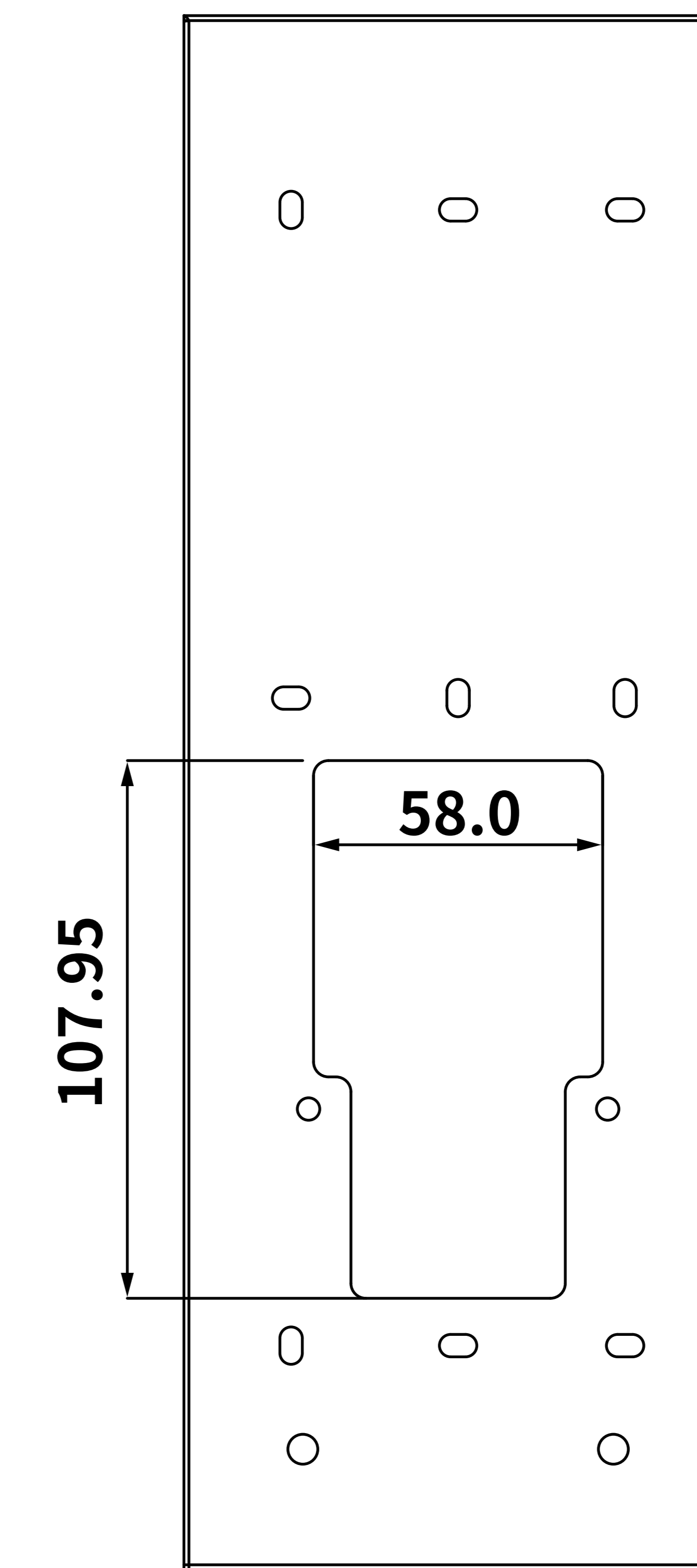

④ BACK VIEW

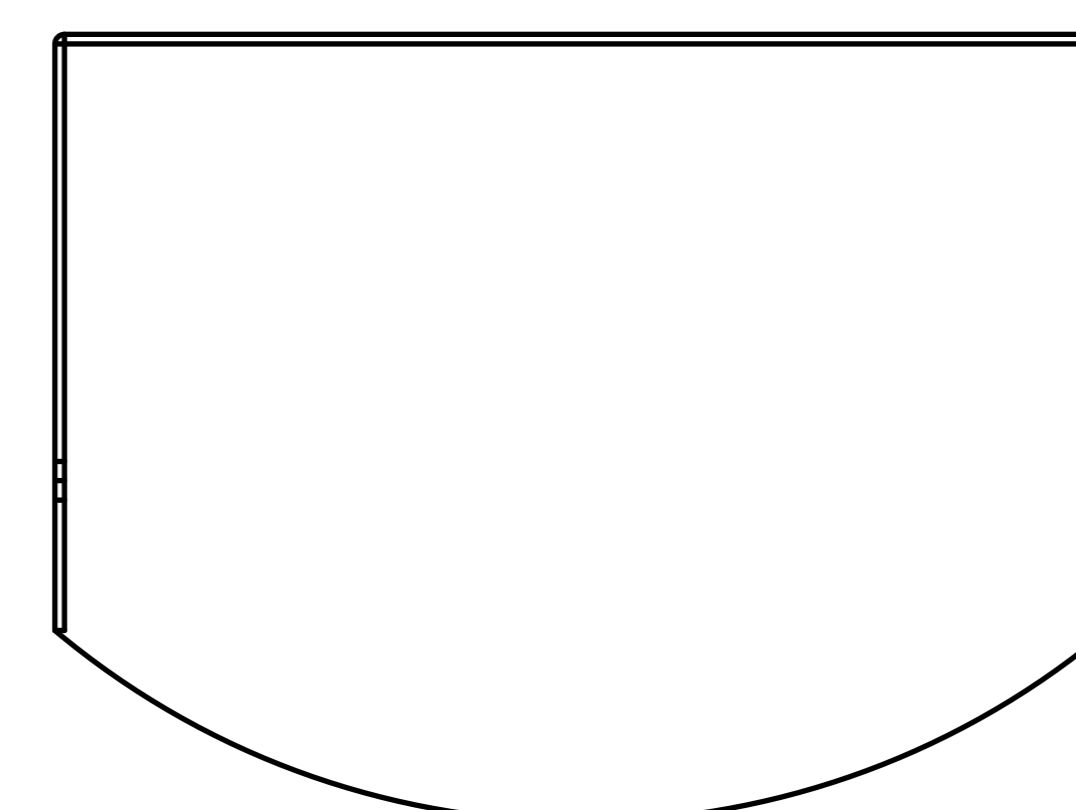

⑤ TOP VIEW

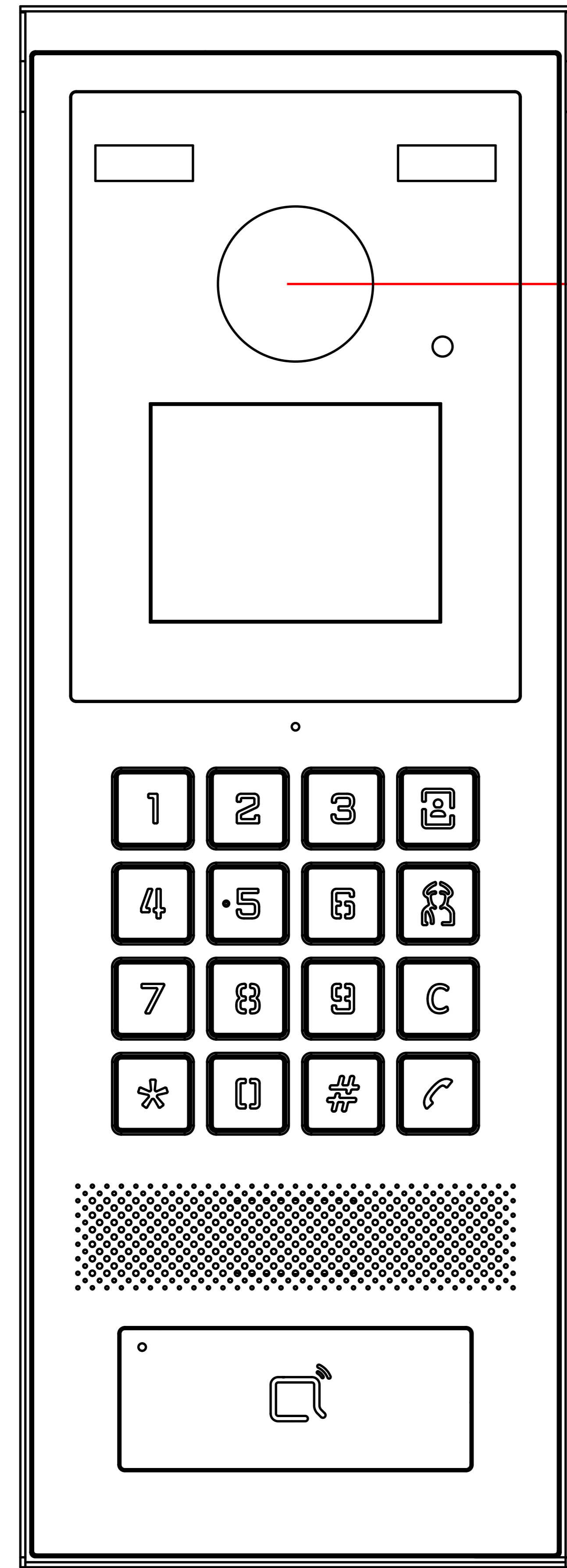

1245.5mm TO BOTTOM OF PANEL

1500mm TO CENTER OF CAMERA

ADA Compliance Requirement

GROUND

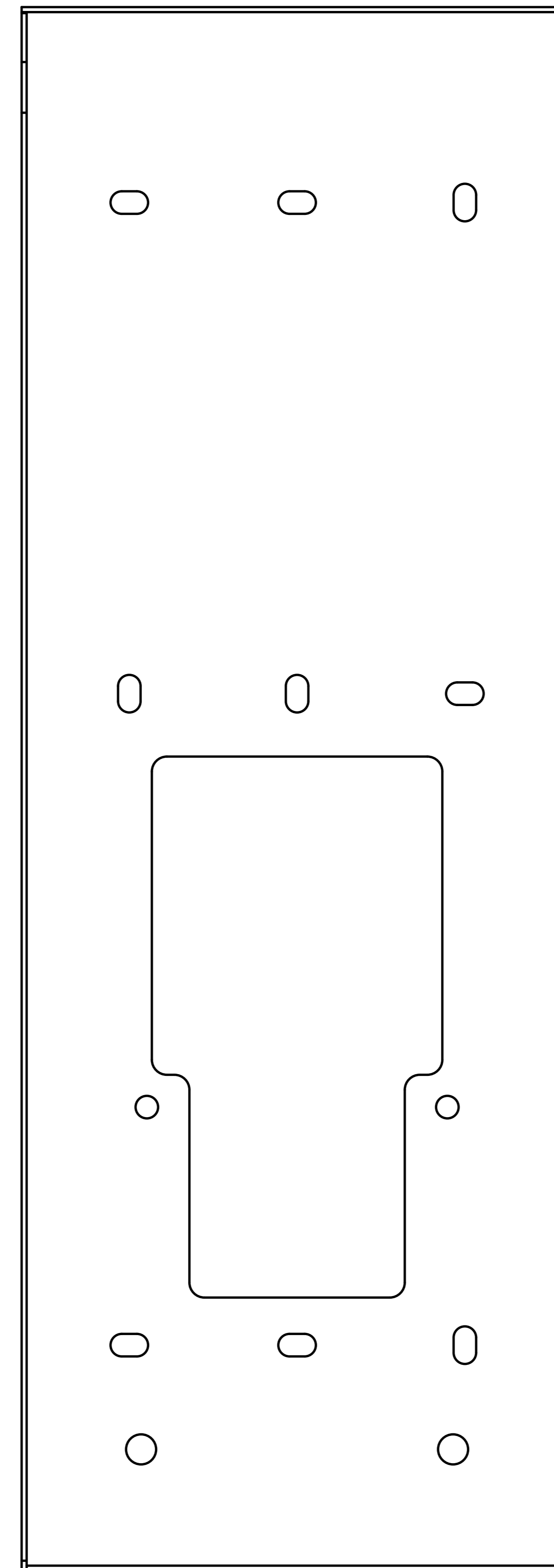

1243mm TO BOTTOM OF BRACKET

GROUND

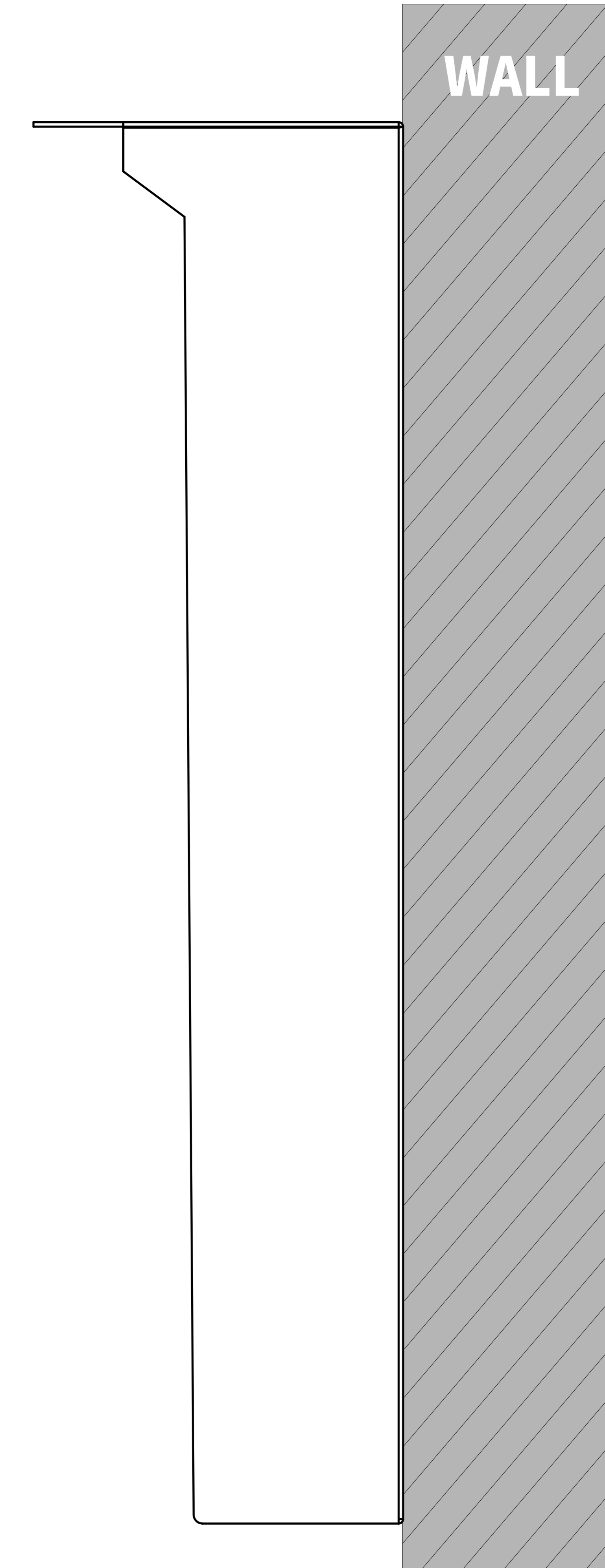

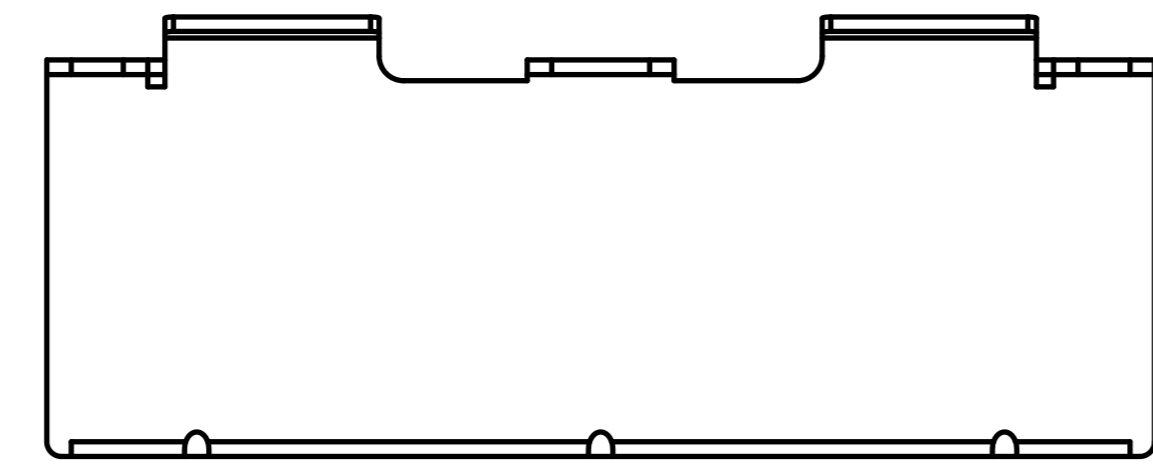

⑥ BOTTOM VIEW



② RIGHT VIEW

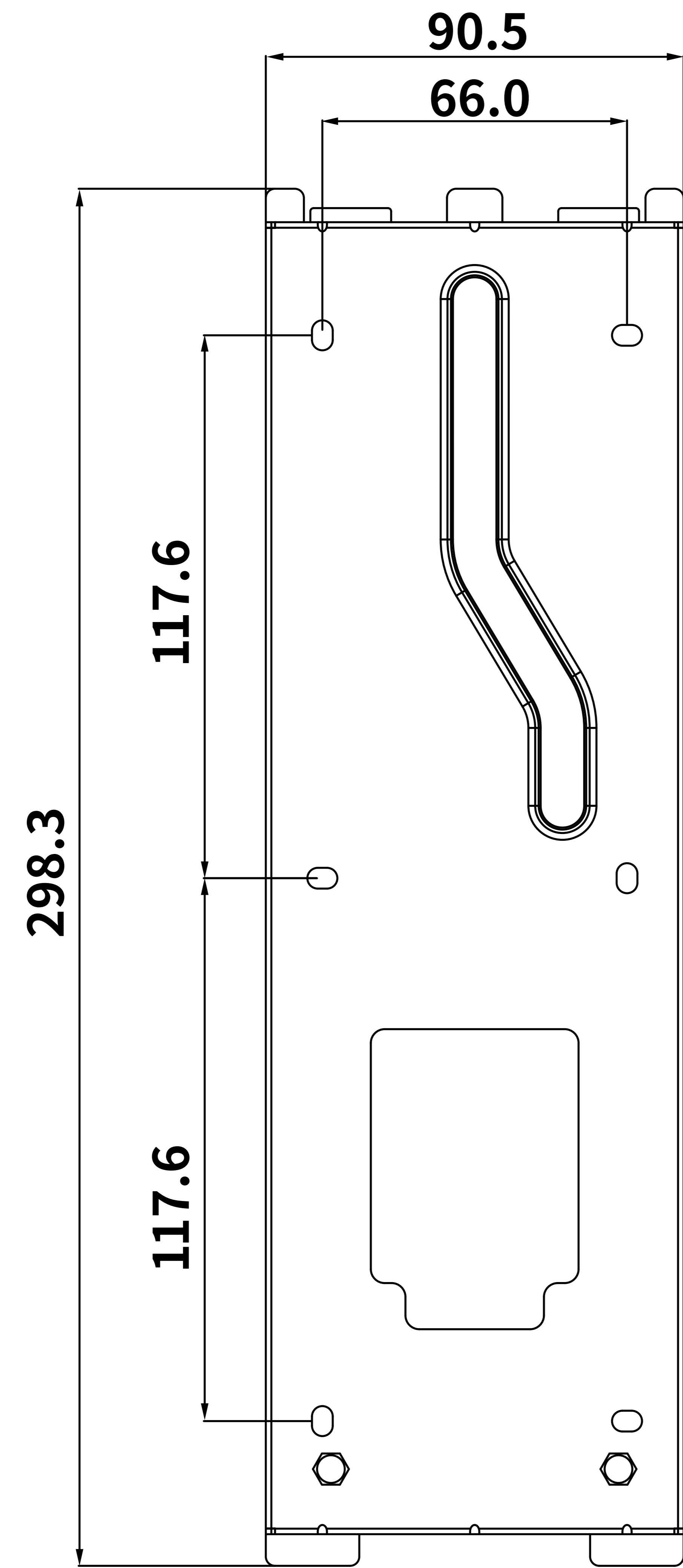

① FRONT VIEW

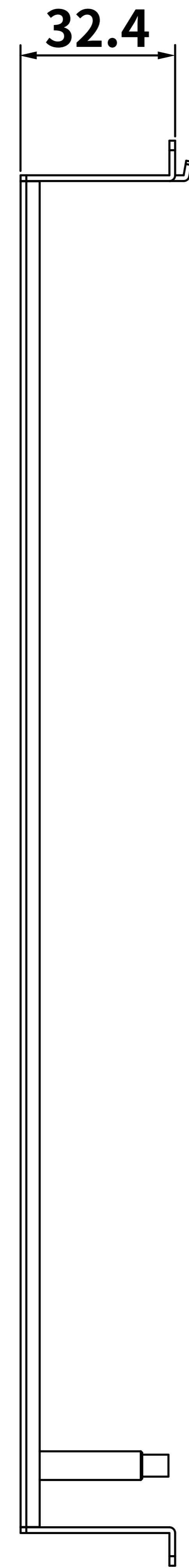

③ LEFT VIEW

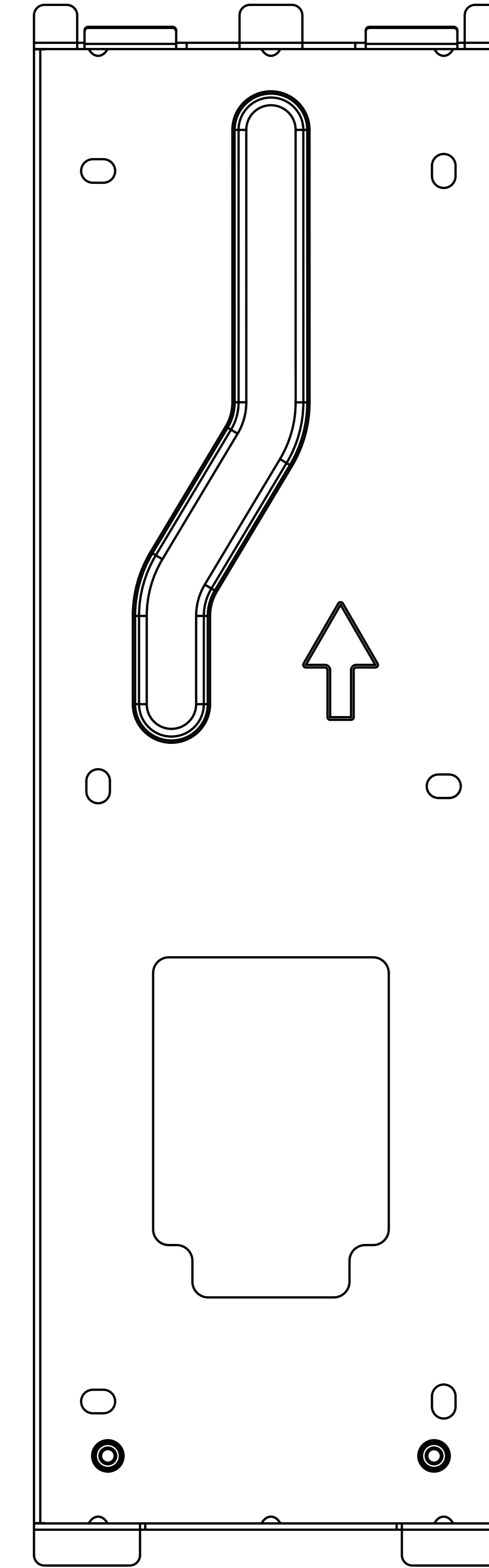

④ BACK VIEW

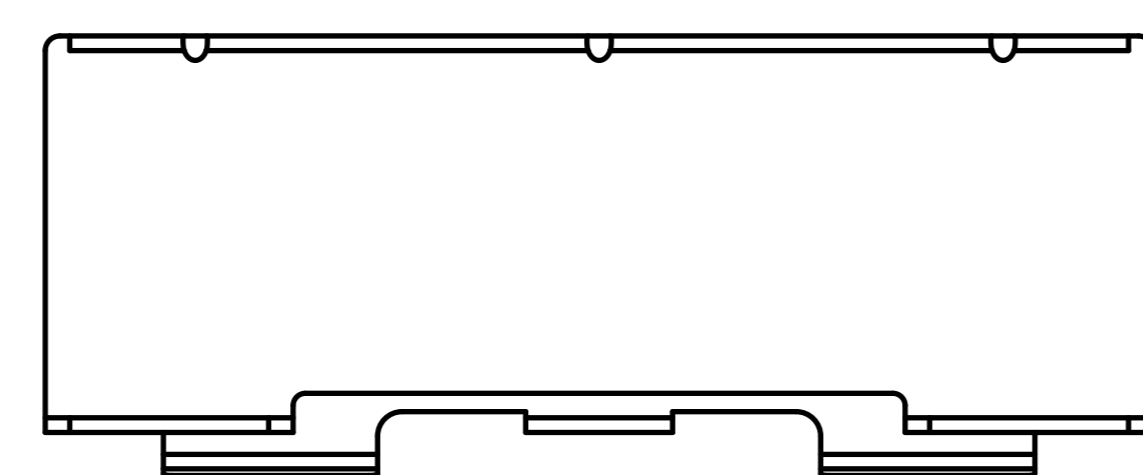

⑤ TOP VIEW

Applicable Model

S532

Drawing Title

Flushing Mounting
Box

Drawing Unit

mm

Drawing Scale

Not to scale

**DRAFT
SUBJECT TO
CHANGE**

Last Revised

Sep 09, 2024

Drawing Version

V1.0

Page

7 of 10

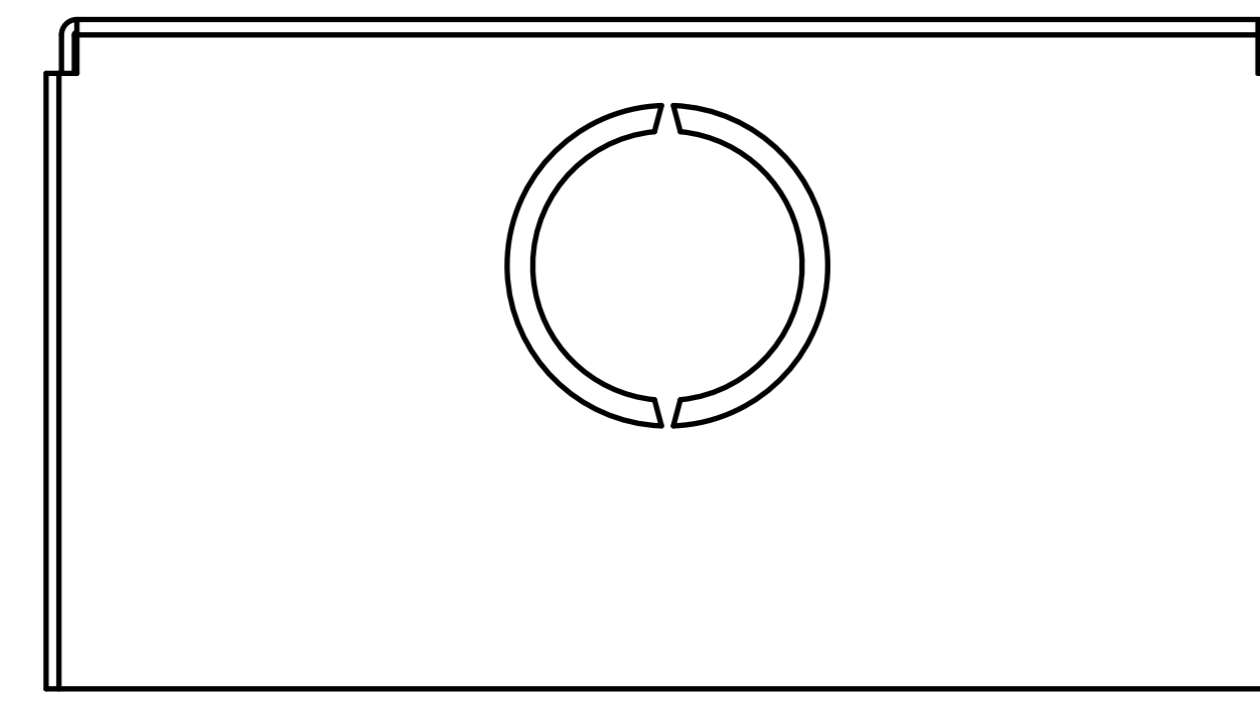

⑤ TOP VIEW

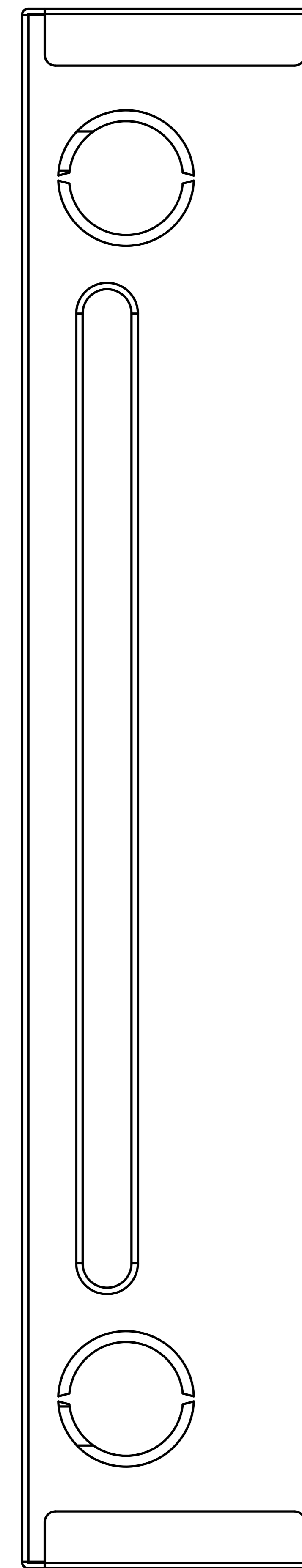

② RIGHT VIEW

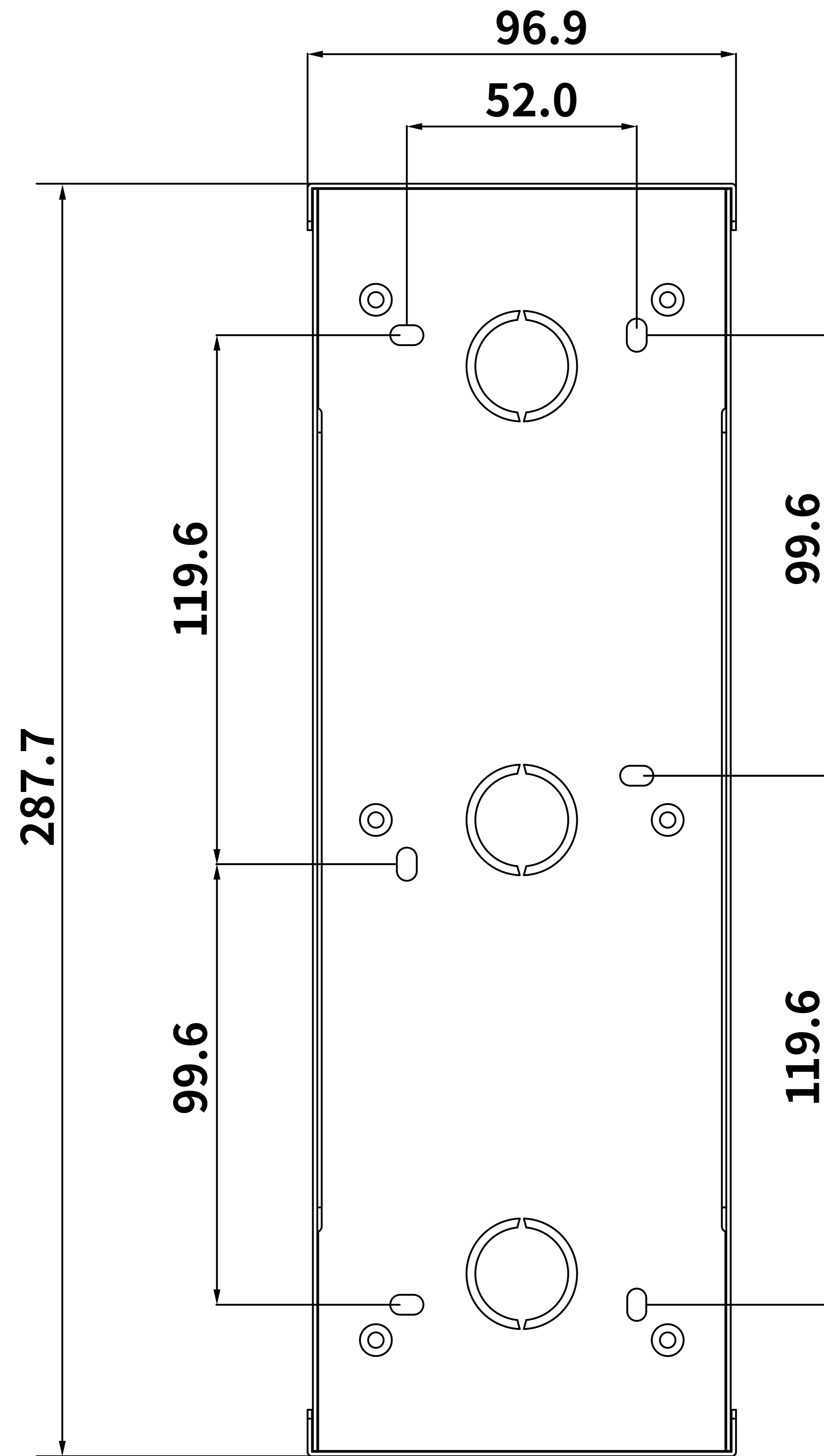

① FRONT VIEW

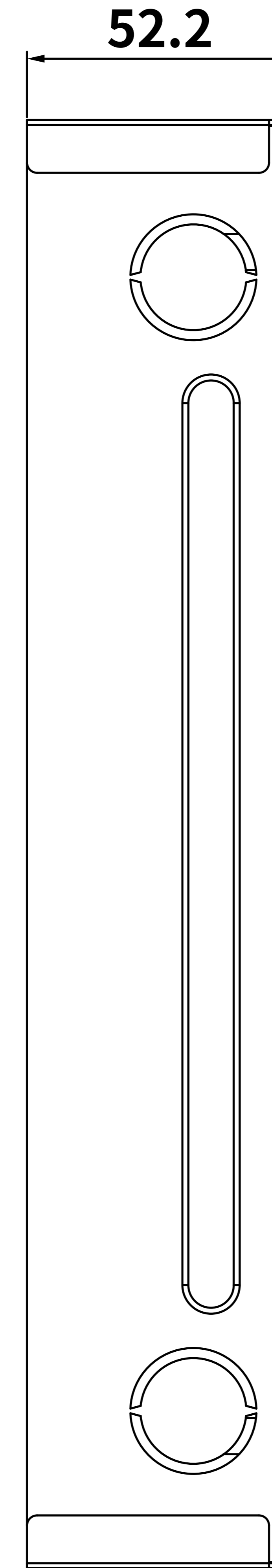

③ LEFT VIEW

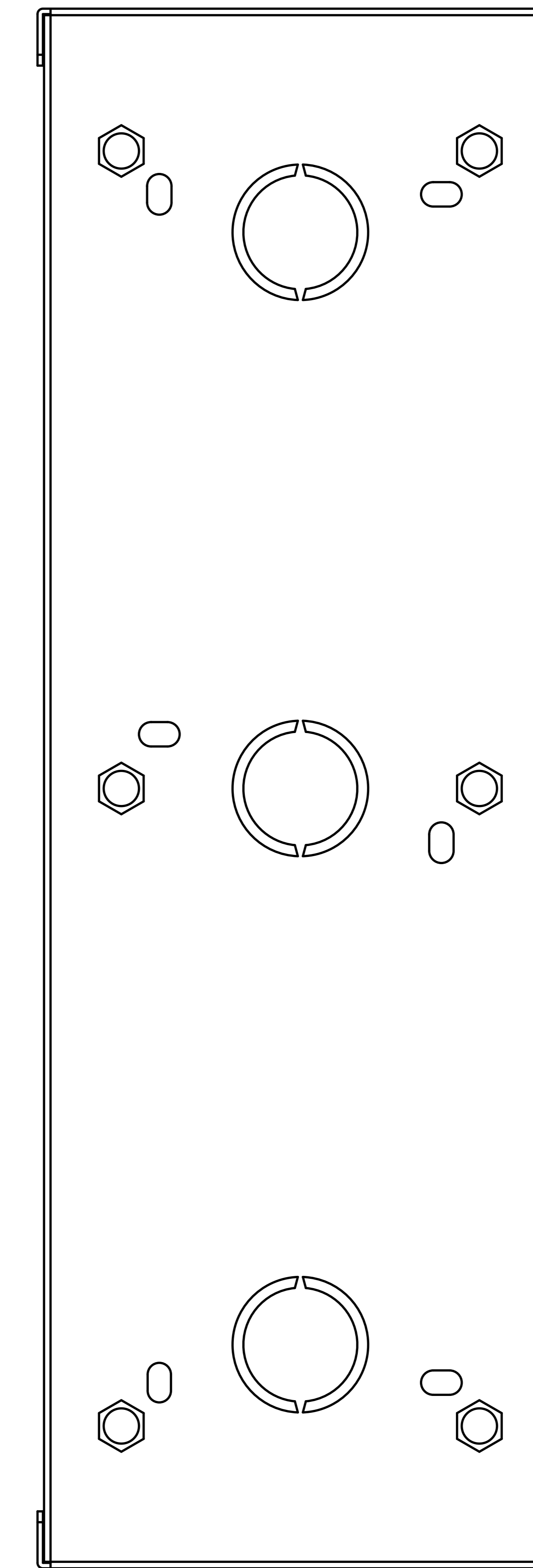

④ BACK VIEW

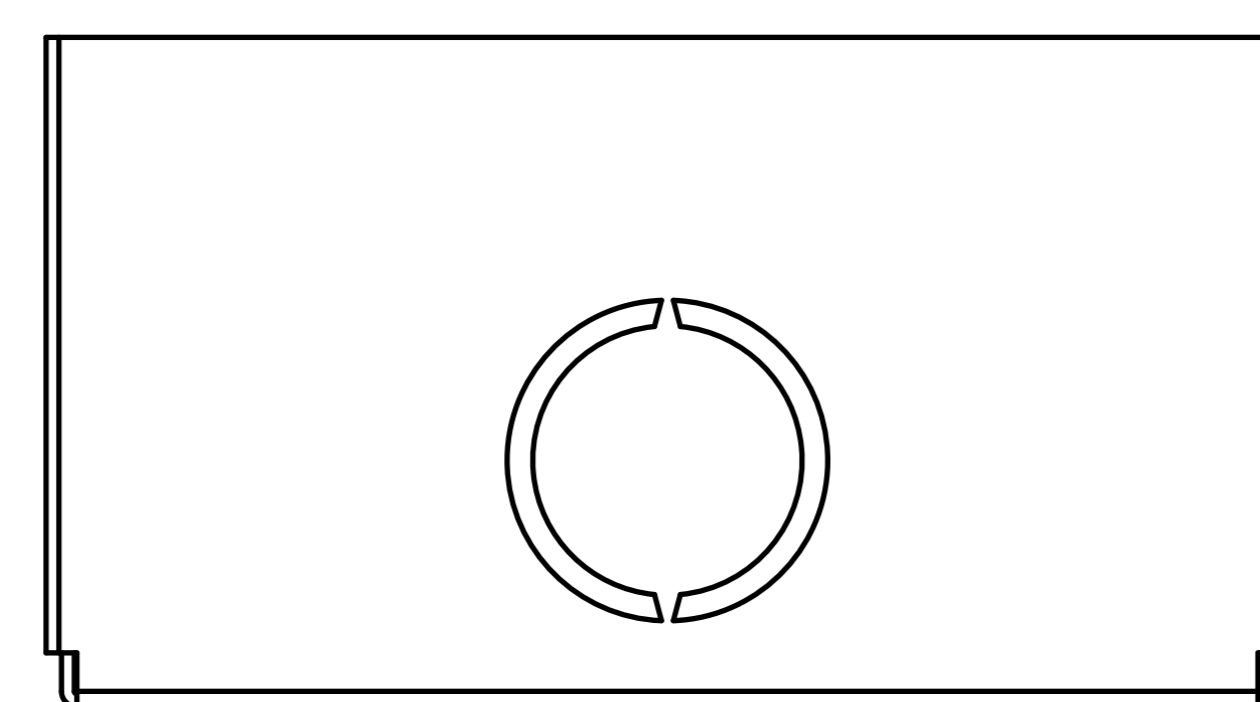

⑥ BOTTOM VIEW

Applicable Model
S532

Drawing Title
Placement

Drawing Unit
mm

Drawing Scale
Not to scale

DRAFT
SUBJECT TO
CHANGE

Last Revised
May 30, 2024

Drawing Version
V1.0

Page
8 of 10

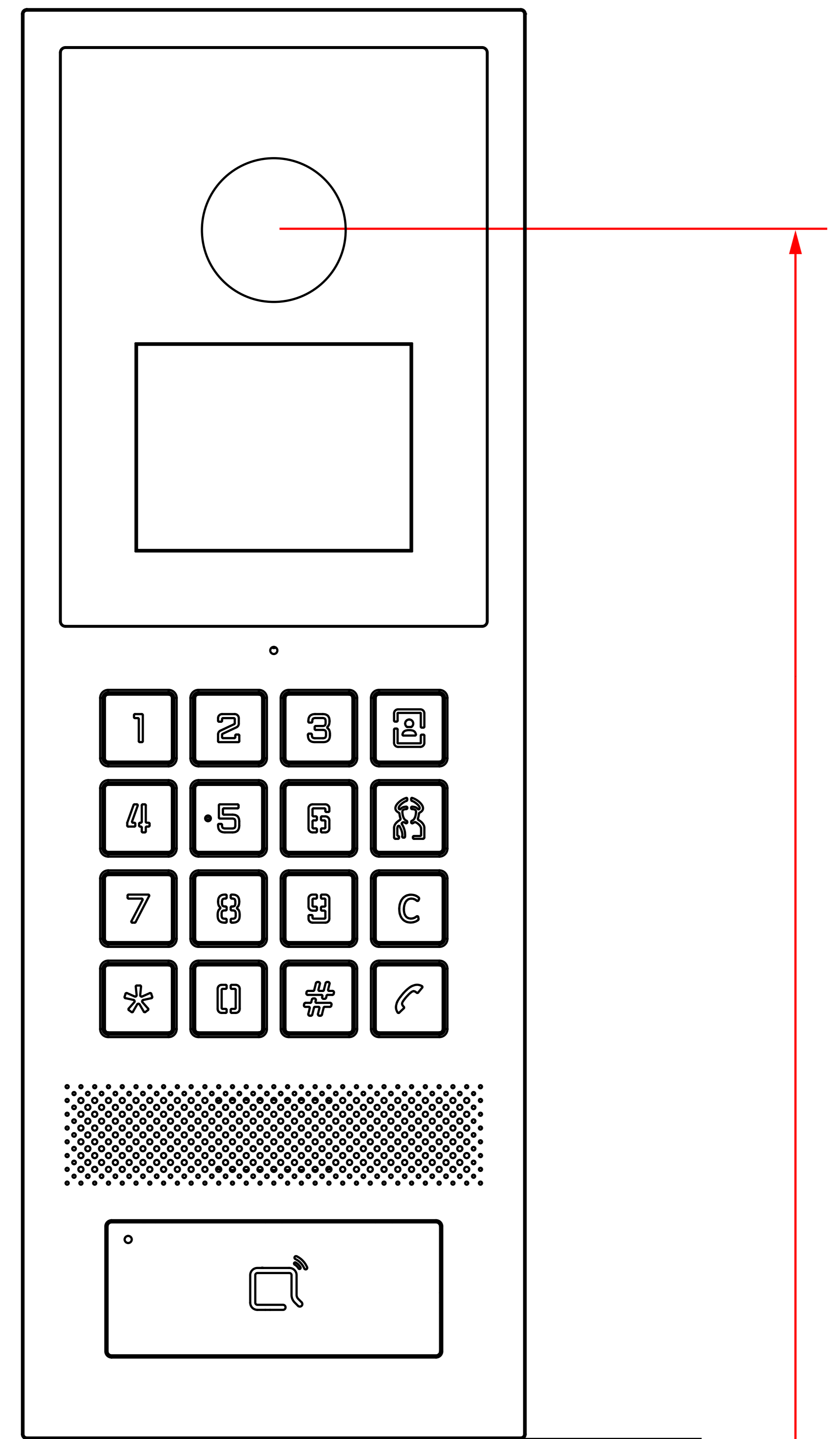

1245.5mm TO BOTTOM OF PANEL

1500mm TO CENTER OF CAMERA

ADA Compliance Requirement

GROUND

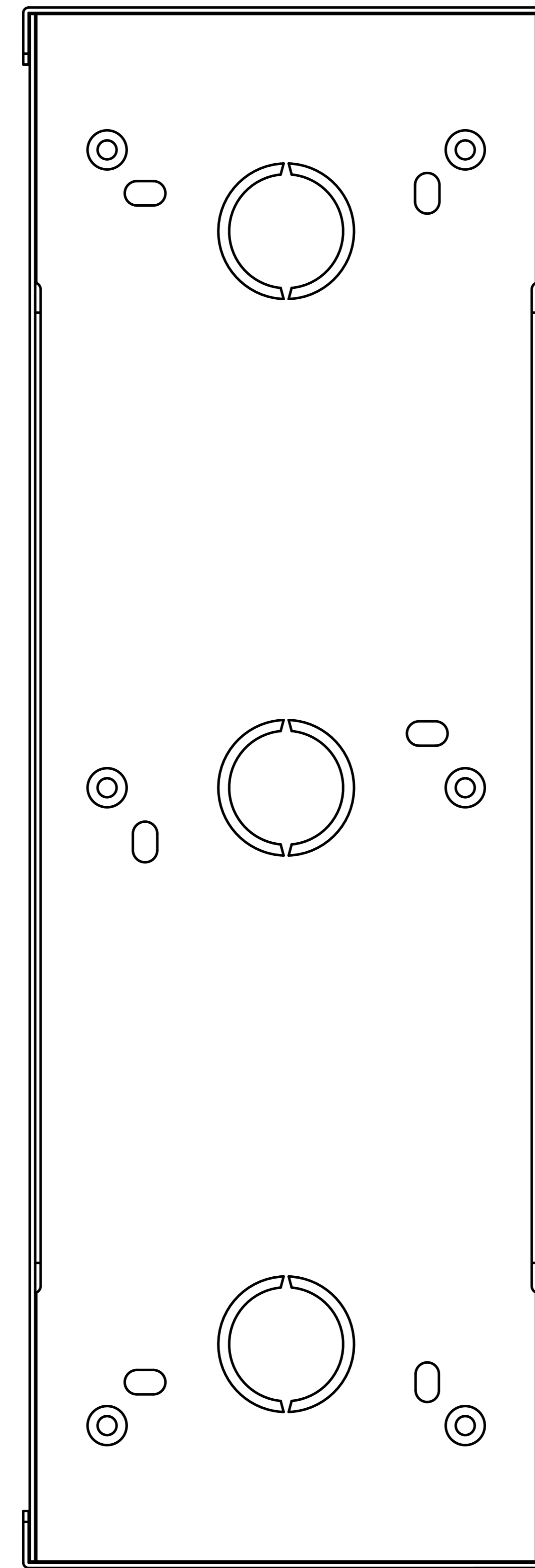

1252mm TO BOTTOM OF BOX

GROUND

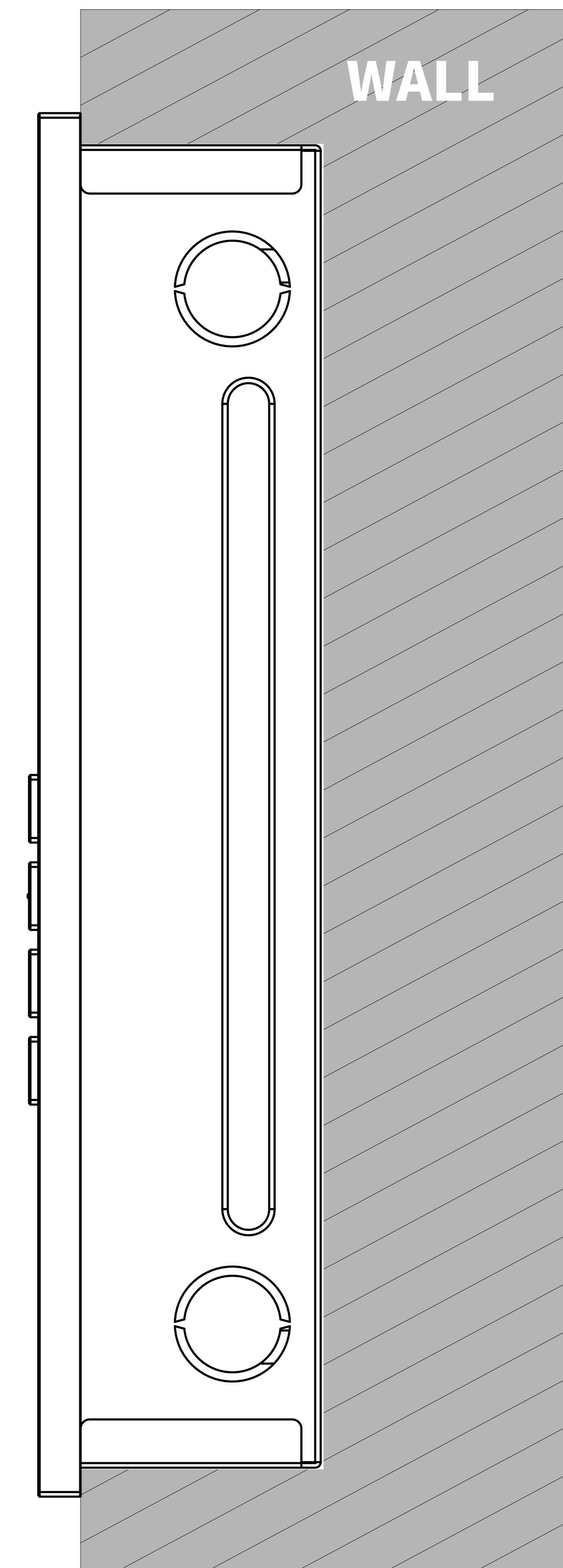

WALL

Applicable Model

S532

Drawing Title

In-Wall Mounting
Rain Cover

Drawing Unit

mm

Drawing Scale

Not to scale

**DRAFT
SUBJECT TO
CHANGE**

Last Revised

May 30, 2024

Drawing Version

V1.0

Page

9 of 10

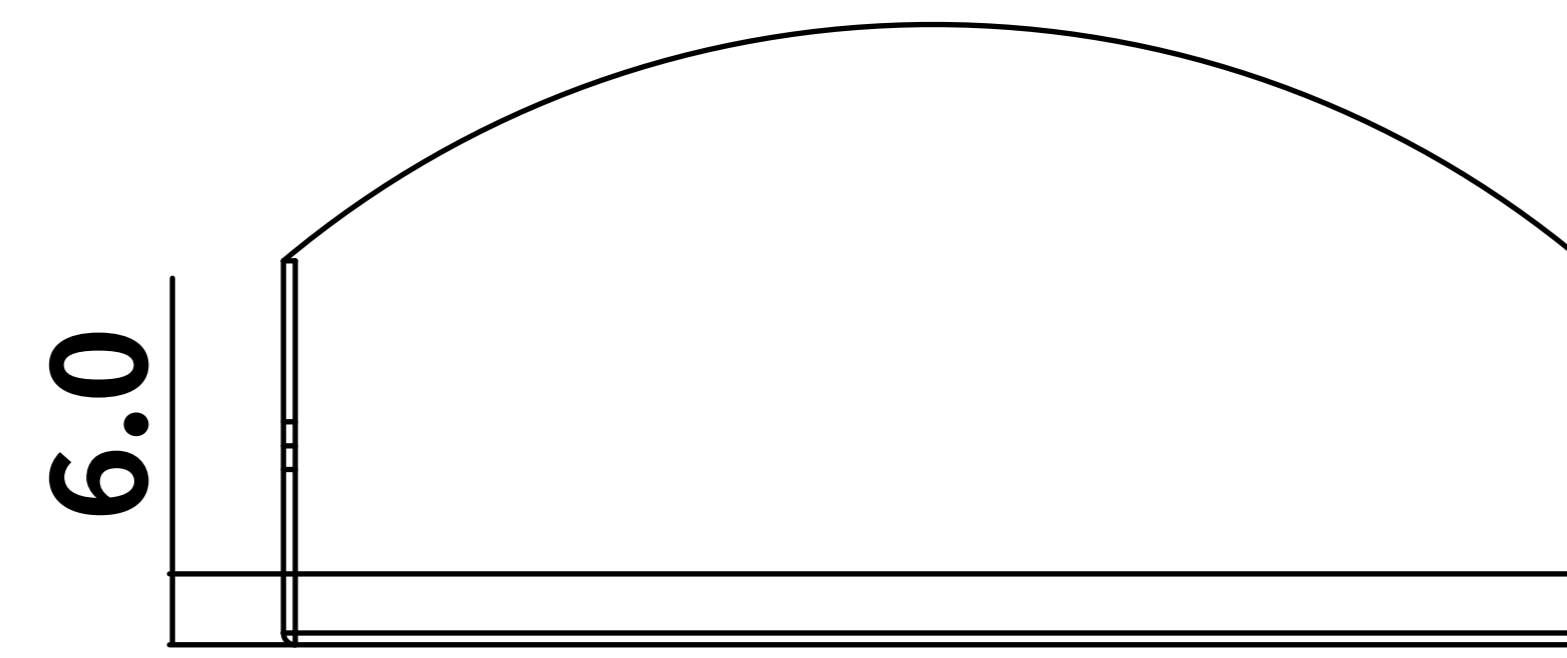

⑥ BOTTOM VIEW

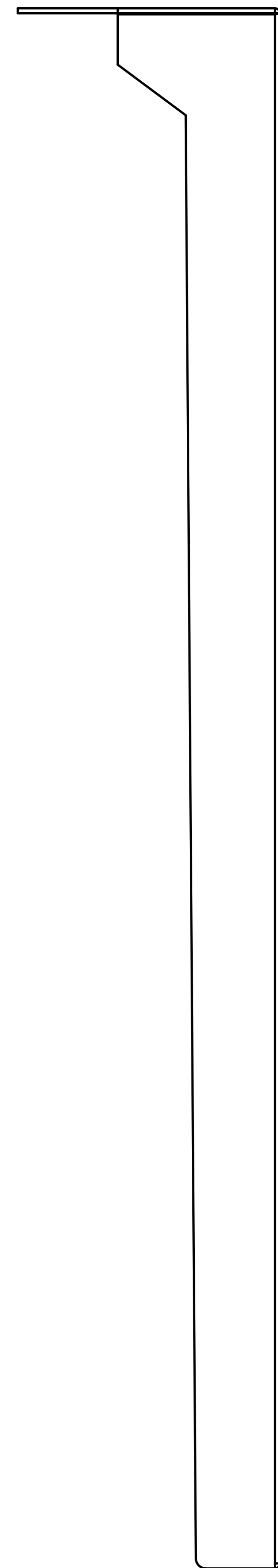

② RIGHT VIEW

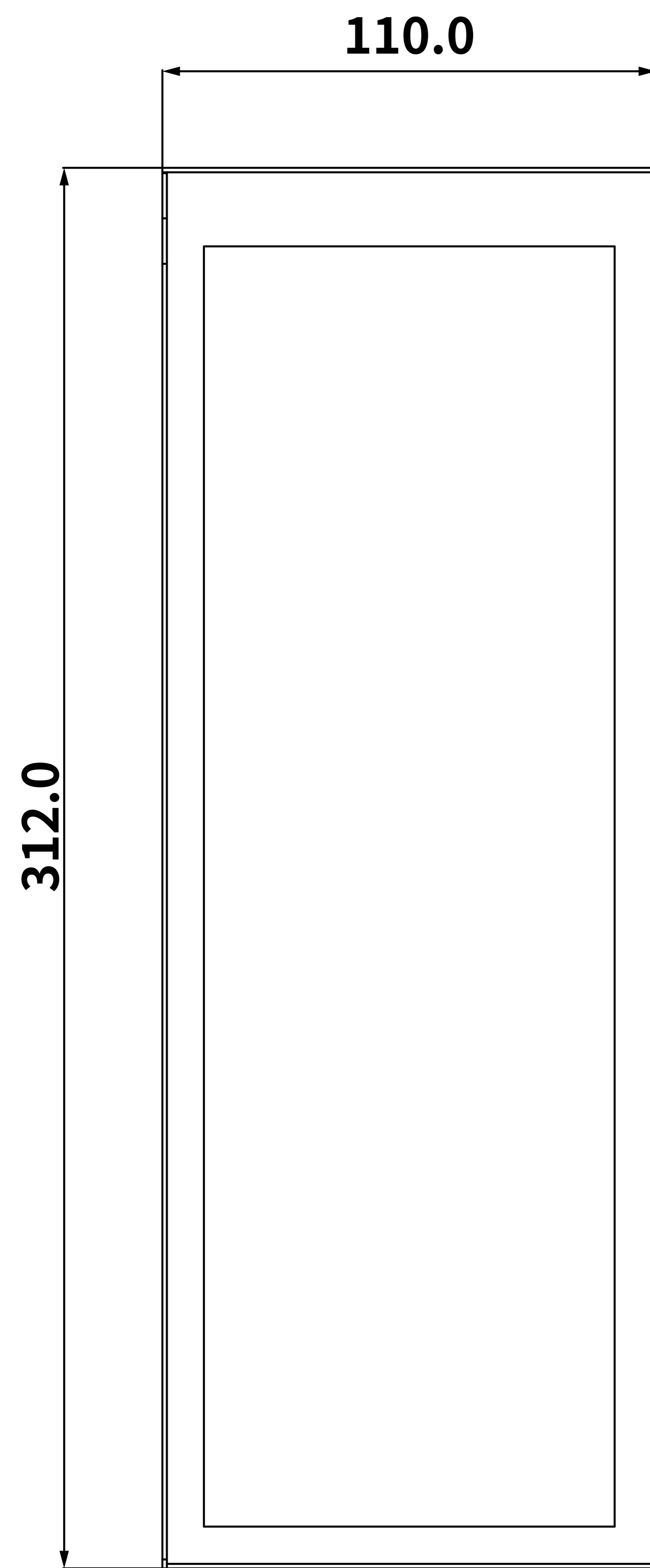

① FRONT VIEW

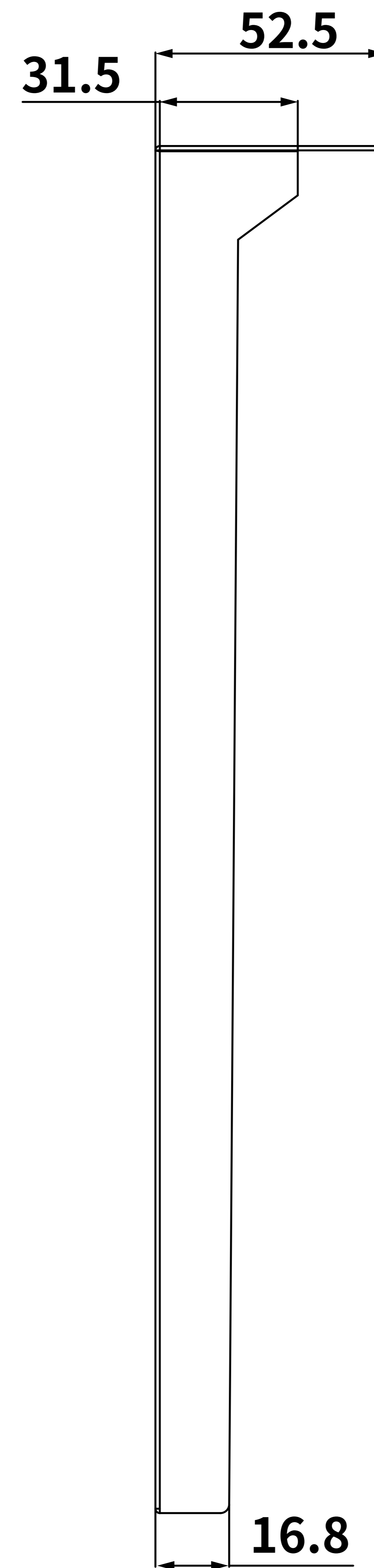

③ LEFT VIEW

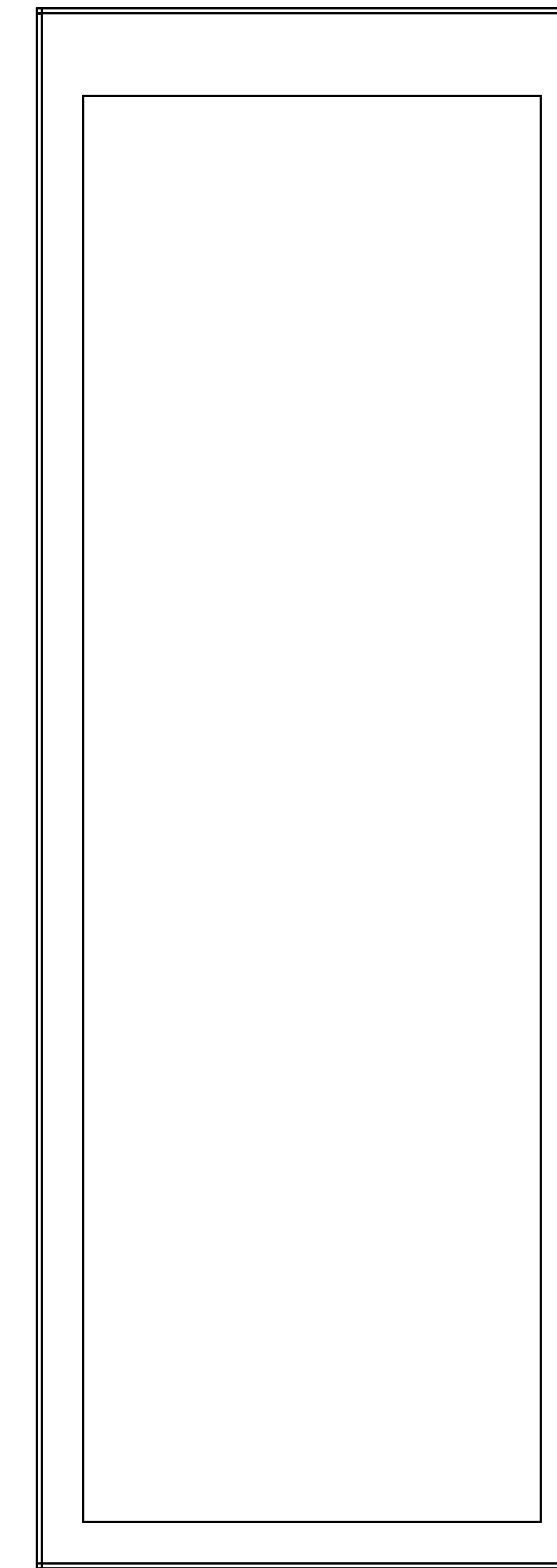

④ BACK VIEW

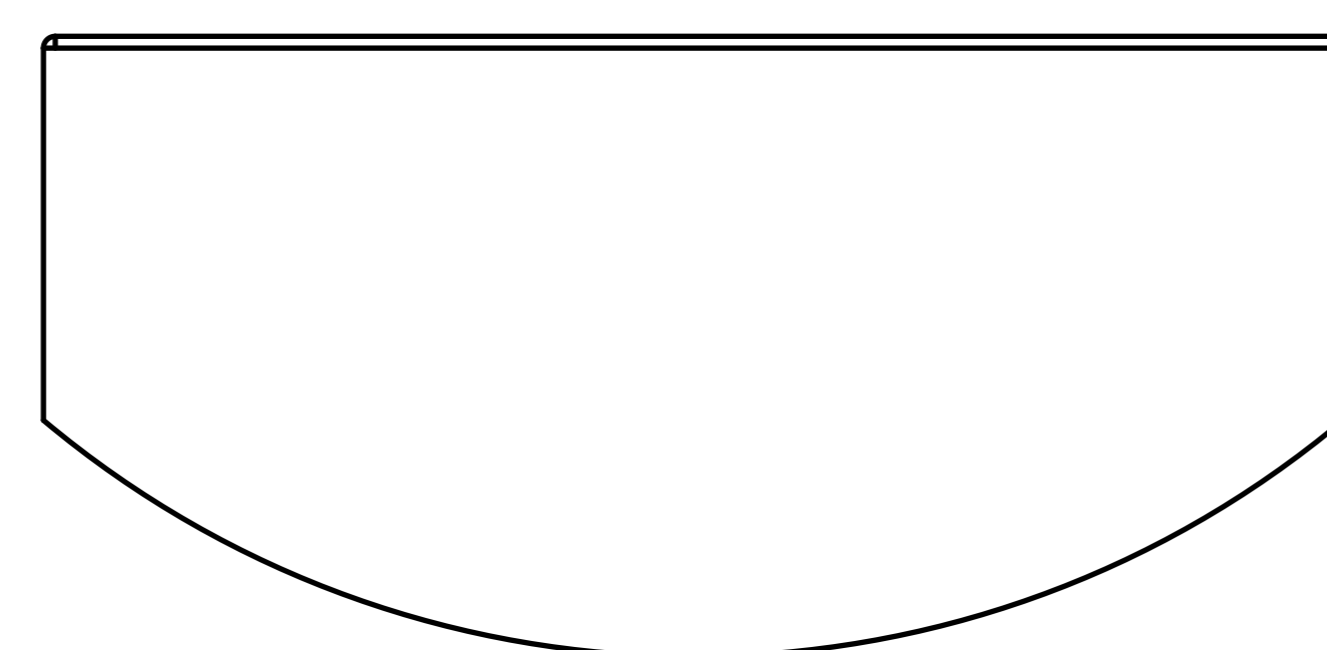

⑤ TOP VIEW

