

Unpacking

Before using the device, check the device model and ensure that the shipped box includes the following items:

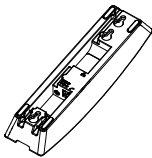

Handset X 1



Base station X 1



Plastic wall anchor X 2

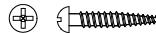

Plastic wall anchor X 2



Phone cord X 1

Product Overview

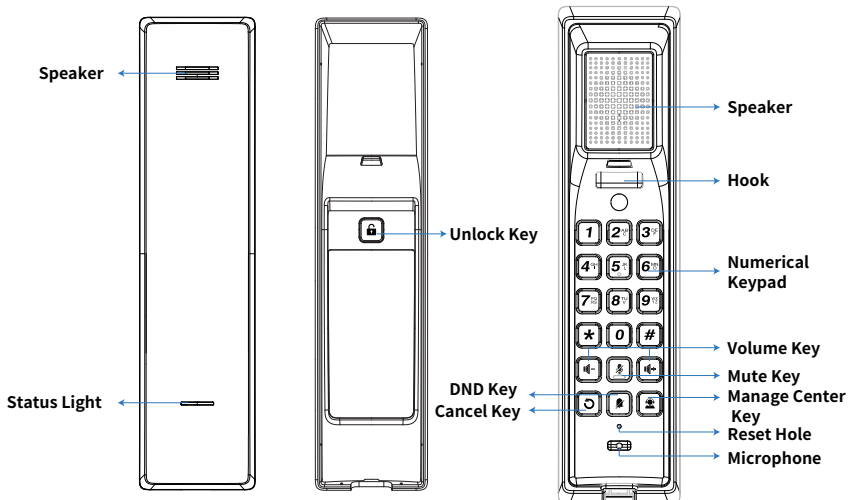

Installation

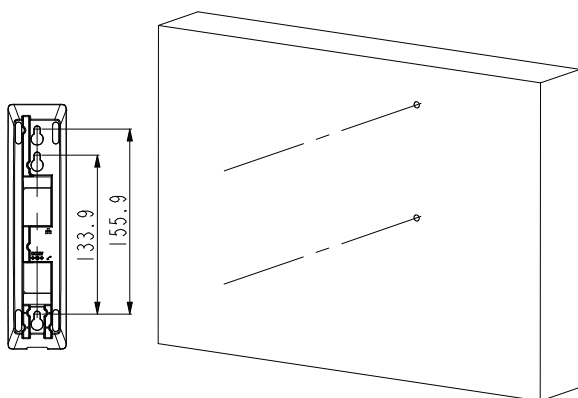

According to the position of cable, drill two holes in the wall, and make sure the distance between these two holes matches the measurement indicated on the figure.

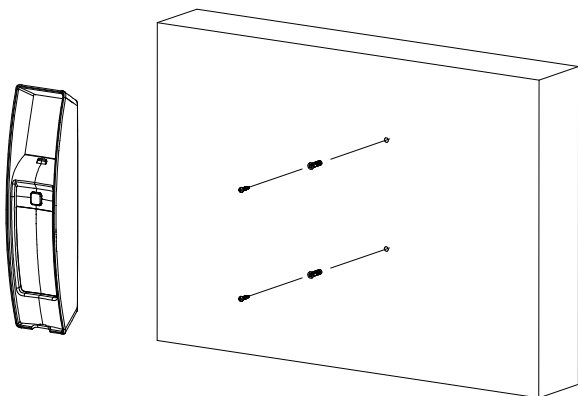

Insert plastic wall anchors into drilled holes.
Turn ST4x20 crosshead screws into plastic wall anchors. Do not fully tighten the screws, and leave some space for placing devices.
Connect cables to corresponding interface to test device. For further details, see “Device Wiring” section.

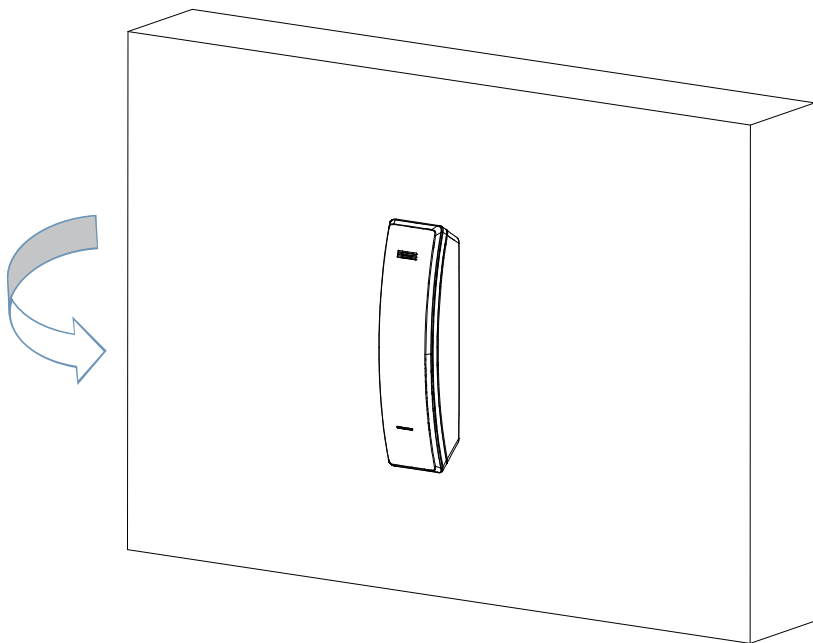

Match up the screw holes with the screws, and then press down the device to attach device securely to the wall.

Device Wiring

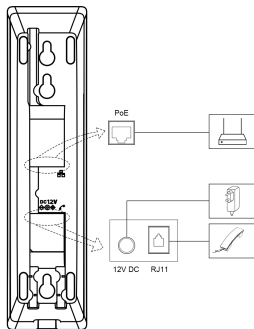

Application Network Topology

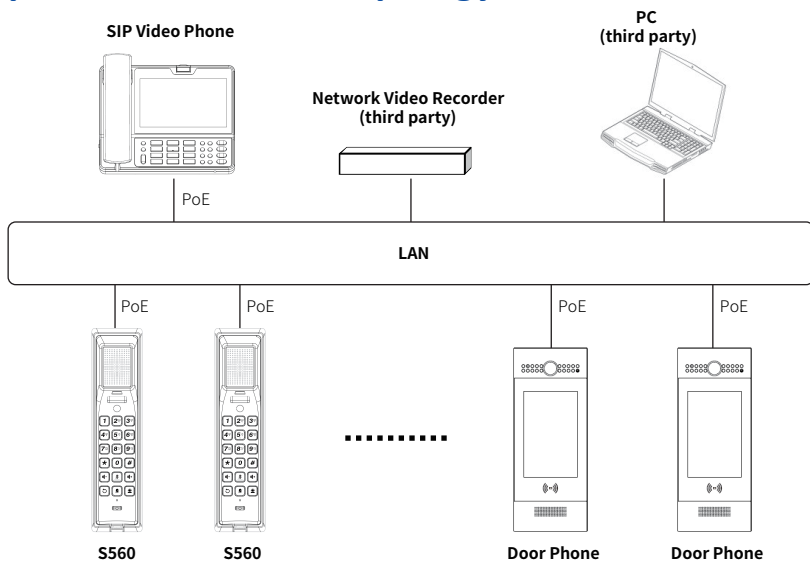

Configuration

1. Access the Website: Press and hold # button, the device will announce IP address. Type in the IP address in browser, then enter the username and password to login (both of them are 'admin' by default).
2. Access basic information: After setting up network and power, enter **Status > Basic** to check Account, Network, Version status.
3. Account Registration: On web UI, go to the path: **Account > Basic** page to fill in the account information, click **Submit** to confirm (please refer to Administrator Guide for more information).

Operation

Make a call

Enter the callee's number or room address to make an audio call.

Unlock

During the talk, you can press **Unlock**  icon on the talking interface to unlock the door.

Speed dial

Long press pre-configured key button for 1 second to make a call.

Do Not Disturb (DND)

In the DND mode, the status light is always on in purple.

Notice Information

Akuvox S560 firmware contains third-party open source software under the terms of the GNU General Public License (GPL). Akuvox is committed to meeting the requirements of the GNU General Public License (GPL) and will make all required source code available. The source code of software under the terms of GNU GPL can be downloaded online, <http://www.akuvox.com/gpl>.

Information contained in this document is believed to be accurate and reliable at the time of printing. This document is subject to change without notice, any update to this document can be viewed on Akuvox' s website: <http://www.akuvox.com> © Copyright 2023 Akuvox Ltd. All rights reserved.



YS56000029